



BUNK BED

Congratulations on your purchase of a Legacy Classic Kids Bed. Every effort has been made to ensure your furniture is of the finest quality. If you find that your furniture has a missing or damaged part, please contact your local Legacy Kids retailer. Please read and follow these instructions carefully.



Model No.

8100 BUNK BED

**READ THESE INSTRUCTIONS CAREFULLY
BEFORE ATTEMPTING TO ASSEMBLE THIS BED.**

SAFETY WARNINGS AND GENERAL NOTES :







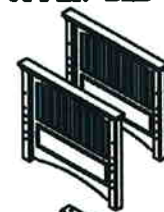

- Follow the information of the warnings on the bunk bed end structure and on the carton. Do not remove the warning label from the bed.
- Always use the recommended size mattress and mattress supports to help prevent the likelihood of entrapment or falls.
- A slat roll must be used to support the mattresses.
- The top surface of the mattress must be at least 5" below the upper edge of the guardrails.
- Do not allow children under 6 years of age to use the upper bunk.
- Periodically check and ensure the guardrail, ladder and other components are in their proper position, free from damage, and all connectors are tight.
- Prohibit horseplay on or under the bed. Always prohibit jumping on the bed.
- Prohibit more than one person on upper bunk.
- Always use the ladder for entering and leaving the upper bunk.
- Do not use substitute parts. Contact your retailer for replacement parts.
- Use of a night-light may provide added safety precaution for a child using the upper bunk.
- Always use guardrails on both sides of the upper bunk.
- If the bunk bed will be placed next to a wall, the guardrail that runs the full length of the bed should be placed against the wall to prevent entrapment between the bed and the wall.
- The use of water or sleep flotation mattresses is prohibited.
- Keep these instructions for future reference.
- We recommend assembling your bunk bed on the shipping carton to protect your floor or carpet. Be certain all staples are out of the box before beginning assembly on the shipping carton.
- **STRANGULATION HAZARD** -- Never attach or hang items to any part of the bunk bed that are not designed for use with the bed; for example, but not limited to, hooks, belts, and jump ropes.

Note: The hardware package is attached to the bottom of the bed end carton #1(8130)

Replacement parts, including additional guardrails, may be obtained from your retailer.

Identifying the Parts

Use the illustrations below to correctly identify each of the parts of your bed

Carton #1 (8130)	Carton #2 (8120)	Carton #3 (8110)	Carton #4 & #5
<p>UPPER BED ENDS (2)</p>  <p>BOTTOM BED ENDS (2)</p>  <p>TOP OF POST(4)</p>  <p>Important: Note the difference between the upper bed and lower bed ends.</p>	<p>SHORT GUARD RAIL (1)</p>  <p>LONG GUARD RAIL (1)</p>  <p>LADDER(1)</p> 	<p>BED RAILS(4)</p> 	<p>SLAT ROLLS(2)</p>  <p>SKU# (4923)</p>

Identifying the Hardware

Identify the hardware using the illustrations below

Note: All hardware pack attached on the bottom of bed end carton #1(8130)

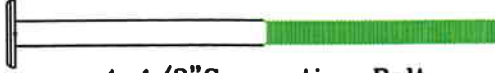
ID# A		Qty 16
4-1/2" Connecting Bolt		

ID# B		Qty 16
Barrel Nut		

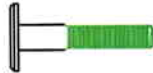
ID# C		Qty 16
2-1/2" Connecting Bolt		

ID# D		Qty 1
4mm Hex Wrench		

ID# E		Qty 16
1-1/4" Flat head Screw		

ID# F		Qty 10
3/4" Wood Screw		

ID# G		Qty 6
2" Connecting Bolt		

ID# H		Qty 16
Hole Cover		

ID# I		Qty 4
4- 1/2" Dia*3/4" pin		

ID# J		Qty 4
Wood Plug for Top of Post		

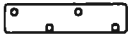
ID# K		Qty 1
Mending Plate		

- Power tools are not recommended for assembling your furniture.
- Give yourself plenty of room to work.
- Due to the size of this bed, it must be assembled within the space it will occupy.
- The assembly will require at least two people to complete.
- Make sure all fasteners are tight.
- Above all, take your time and read the instructions carefully.

Tools Required

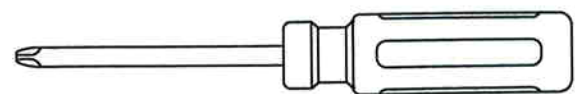

Phillips Head Screwdriver

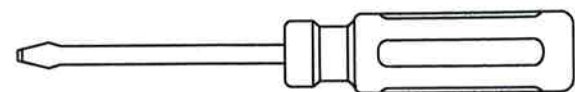

Standard Head Screwdriver

Step

1

1. Select the BED RAILS as shown.
2. Insert the BARREL NUTS (B) into the holes in each BED RAIL as shown in (Figure 1). Make sure the slot on the top of the BARREL NUT is aligned with the hole in the end of the RAILS (Figure 2). Once inserted, use a STANDARD SCREWDRIVER to align the BARREL NUT. This will ensure proper alignment with the bolts later.

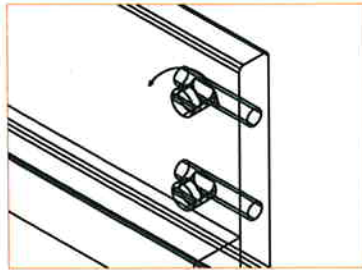

Figure 2

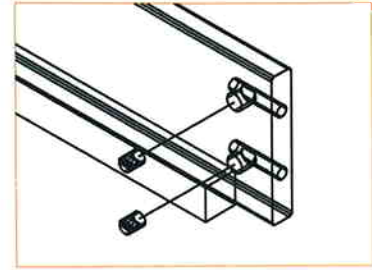
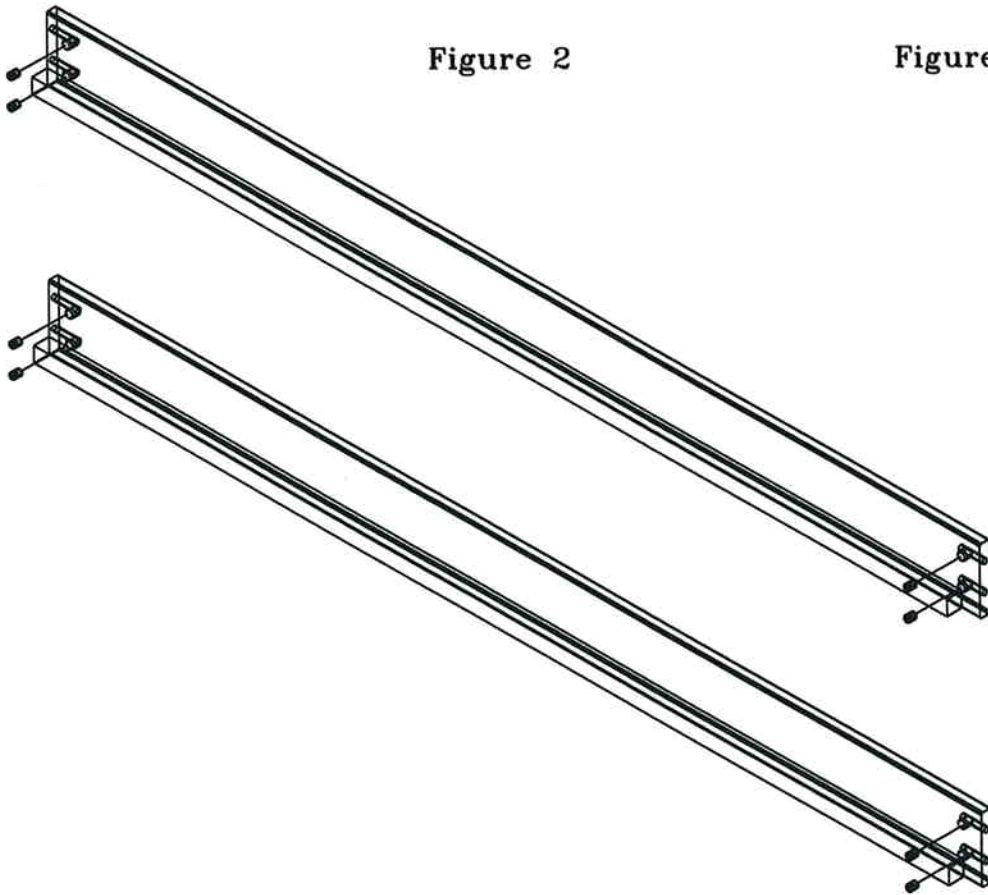



Figure 1



Hardware Used In This Step

ID# B	 Barrel Nut	Qty 16
----------	---	-----------

Step
2

1. Select both sets of BED ENDS and BED RAILS.
2. Attach the BED RAILS to the BED ENDS as shown using the 4 1/2" CONNECTING BOLTS (A). Use the HEX WRENCH (D) to tighten the CONNECTING BOLTS (A).
Note: Be careful to attach the upper bed ends together and the lower bed ends together. They are different. Do not mix them.
3. Cover the two extra holes on the posts use BOLTS (C) and hole cover (H).
4. Please note the BARREL NUTS may have to be turned slightly to start the bolts threading.

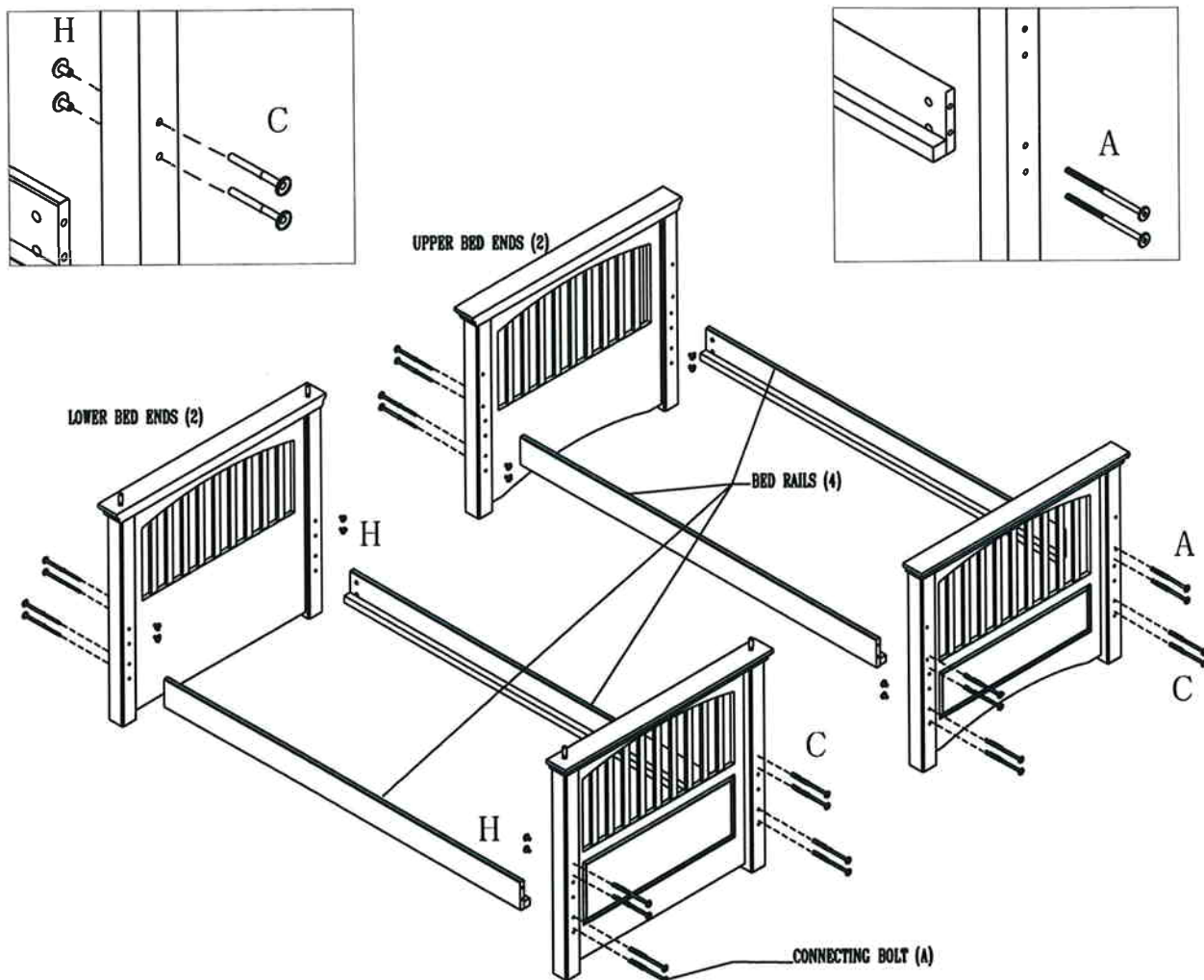



***Note: Upper bed assembly-Always use upper set of holes. Lower bed assembly-Use lower set of holes for normal use. Use upper set of holes for use with optional under-bed unit.**

Hardware Used In This Step

ID# A		Qty 16
4-1/2" Connecting Bolt		

ID# D		Qty 1
4mm Hex Wrench		

ID# C		Qty 16
2-1/2" Connecting Bolt		

ID# H		Qty 16
Hole Cover		

Step

3

Note:

problems.

Call your retailer if you have any questions or

1. Select the **BED ASSEMBLIES** and the **SLAT ROLLS**.
2. Lay the **SLAT ROLLS** onto the side rails. Spread the **SLAT ROLL** so it extends fully and fits into the cleat notches.
3. Secure the **SLAT ROLL** in place by threading a 1- 1/4" **FLAT HEAD SCREW** through the predrilled holes near the ends of the **SLAT ROLLS** and into the cleats on the **SIDE RAILS** as shown. Repeat on all 4 **SIDE RAILS**.

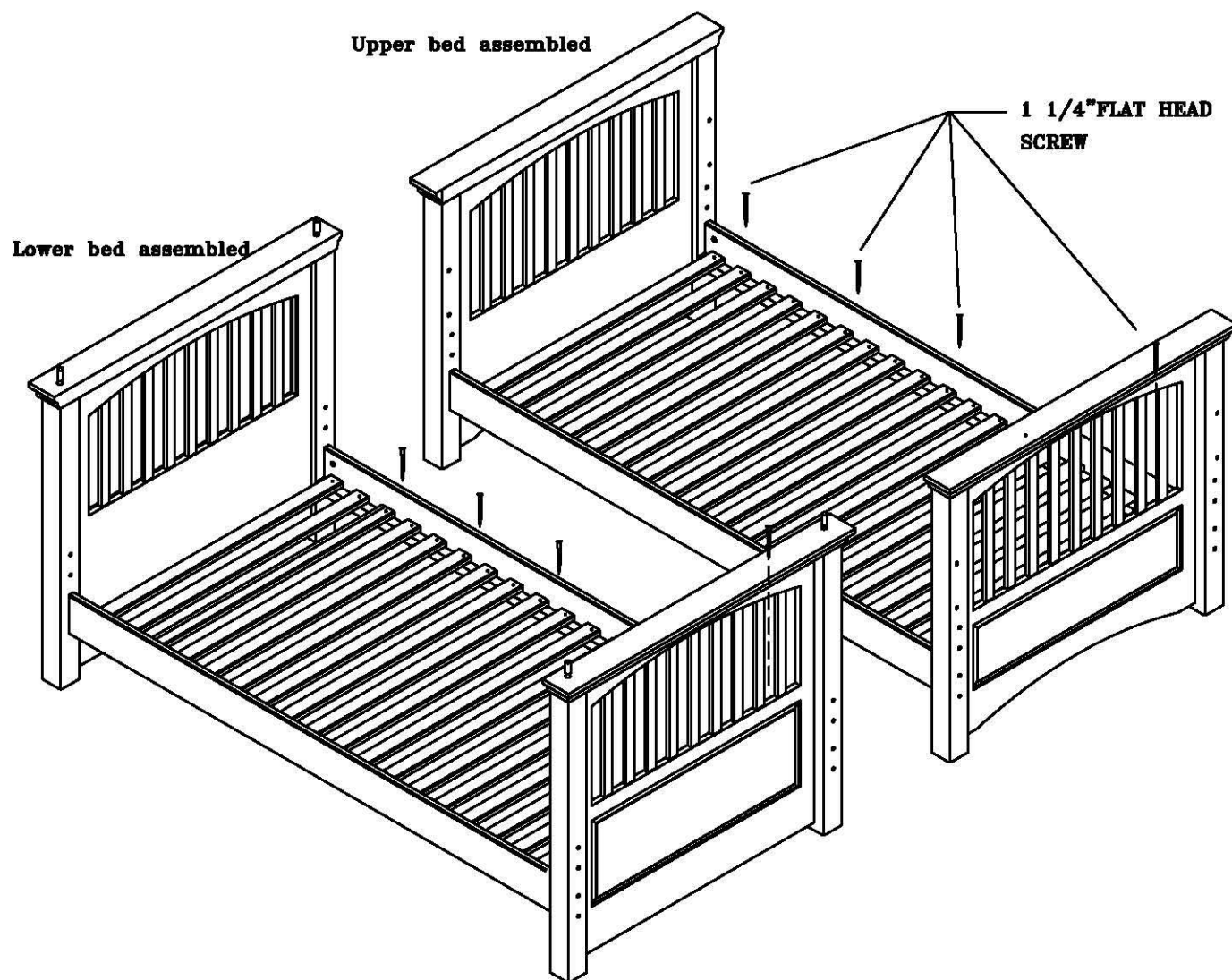

Hardware Used In This Step

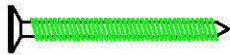
ID#		Qty
E	 1- 1/4" Flat head Screw	16

Step

4

1. Select the long guard rail and position as shown by sliding the notched ends over the side rail. Secure in place using connecting bolts (G) to attach the ends of the guard rail to bed ends. (Figure 1), complete the attachment by attaching the mending plate (K) to the inside of the side rail as shown, attach with 2 wood screws (F).

2. Select the short guard rail and position on opposite side rail. One end of the short guard rail should attach to a bed end leaving an opening on the other end for the ladder.

Note: Position of ladder should be decided prior to attaching **short guard rail**. Secure the end of the **short guard rail** touching the desired bed- end using 2 **connecting bolts (G)**. (Figure 1). Attach the **mending plate (K)** to the inside of the end-stile on the short guard rail using 2 **wood screws (F)** into the Pre-drilled holes. Attach the mending plate to the inside of side rail using 2 **wood screws (F)**.(Figure 2)

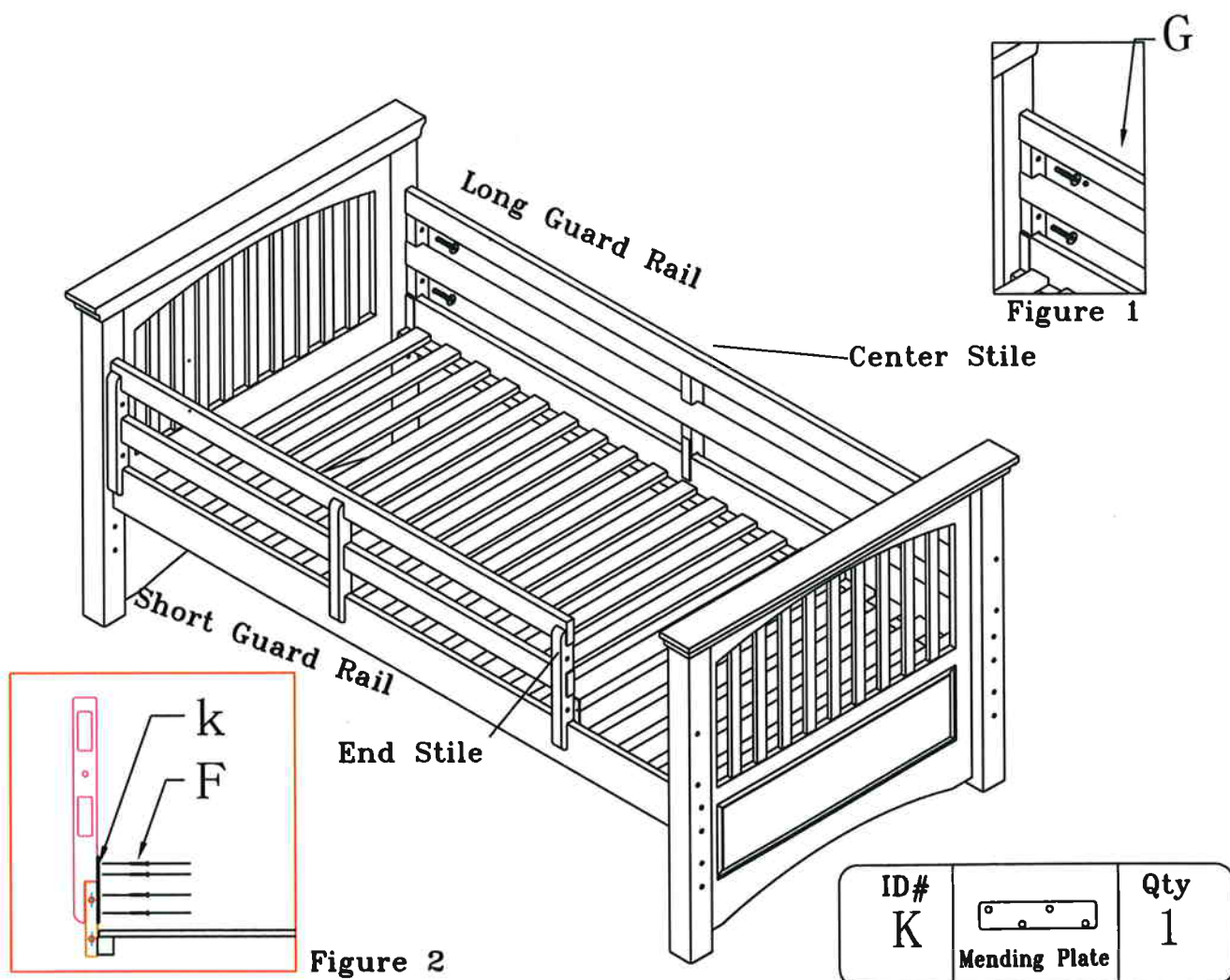

Hardware Used In This Step

ID#		Qty
F	3/4" Wood Screw	8

ID#		Qty
G	2" Connecting Bolt	6

Step

5

1. Insert the 4 PINS (I) into the bed post holes shown in the top edges of the LOWER BED.
2. With the help of a friend, lift the upper BED ASSEMBLY and place it on top of the LOWER BED. Make sure all 4 upper posts drop down onto the pins completely.

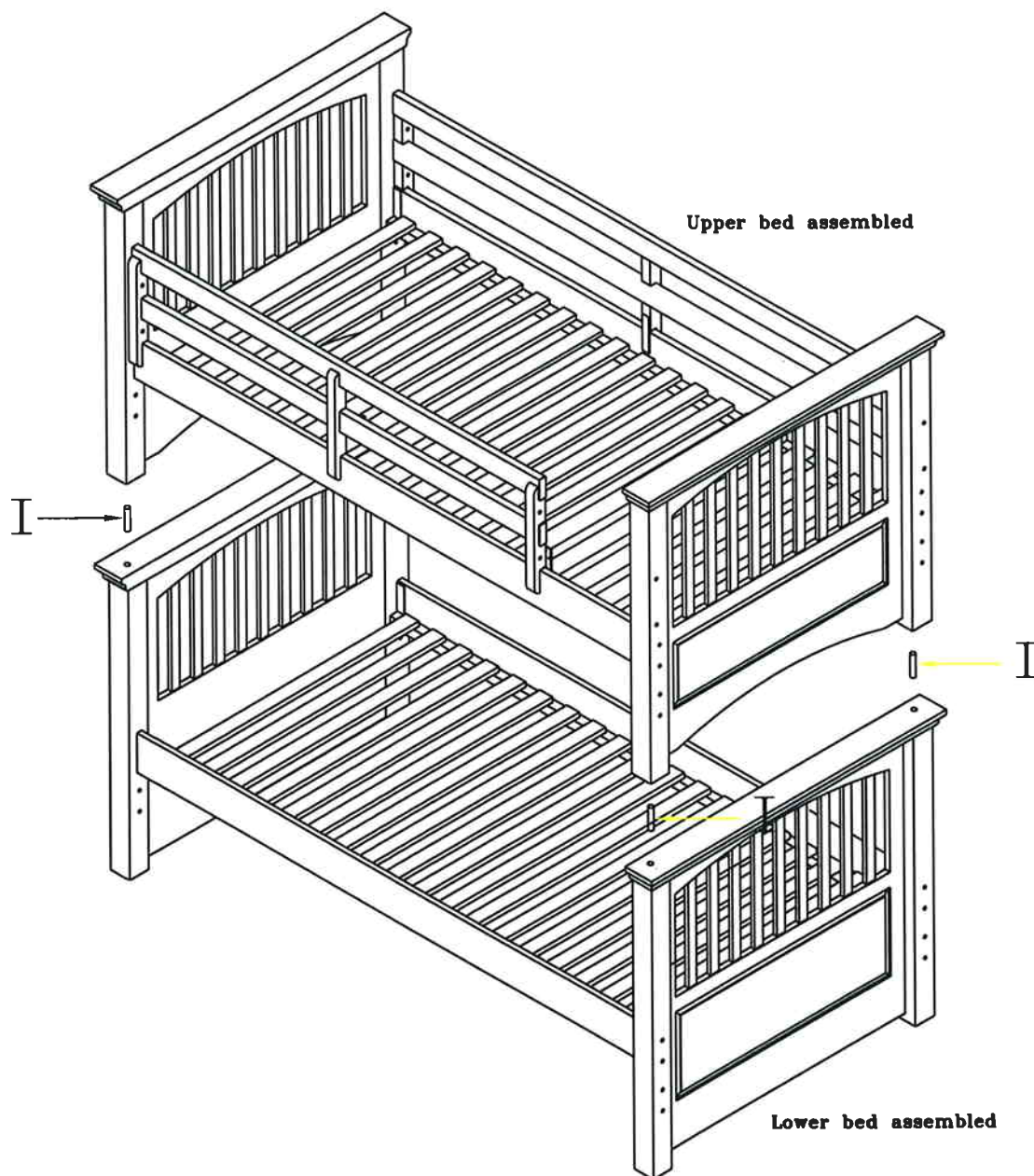

Hardware Used In This Step

ID#		Qty
I	 4-1/2" Dia*3/4" pin	4.

Step

6

1. Put the LADDER in place by hooking it over the top edge of the BED RAIL in the location as shown. Secure the LADDER in place by driving a 3/4" FLAT HEAD SCREW (F) through each LADDER HOOK and into the BED RAIL. Be sure to note the BEDDING SPECIFICATIONS in the back of these instruction. In order to avoid the possibility of a fall or entrapment, these specifications must be strictly adhered to.
2. Your bed is now complete, please add correct size mattresses and use safely.

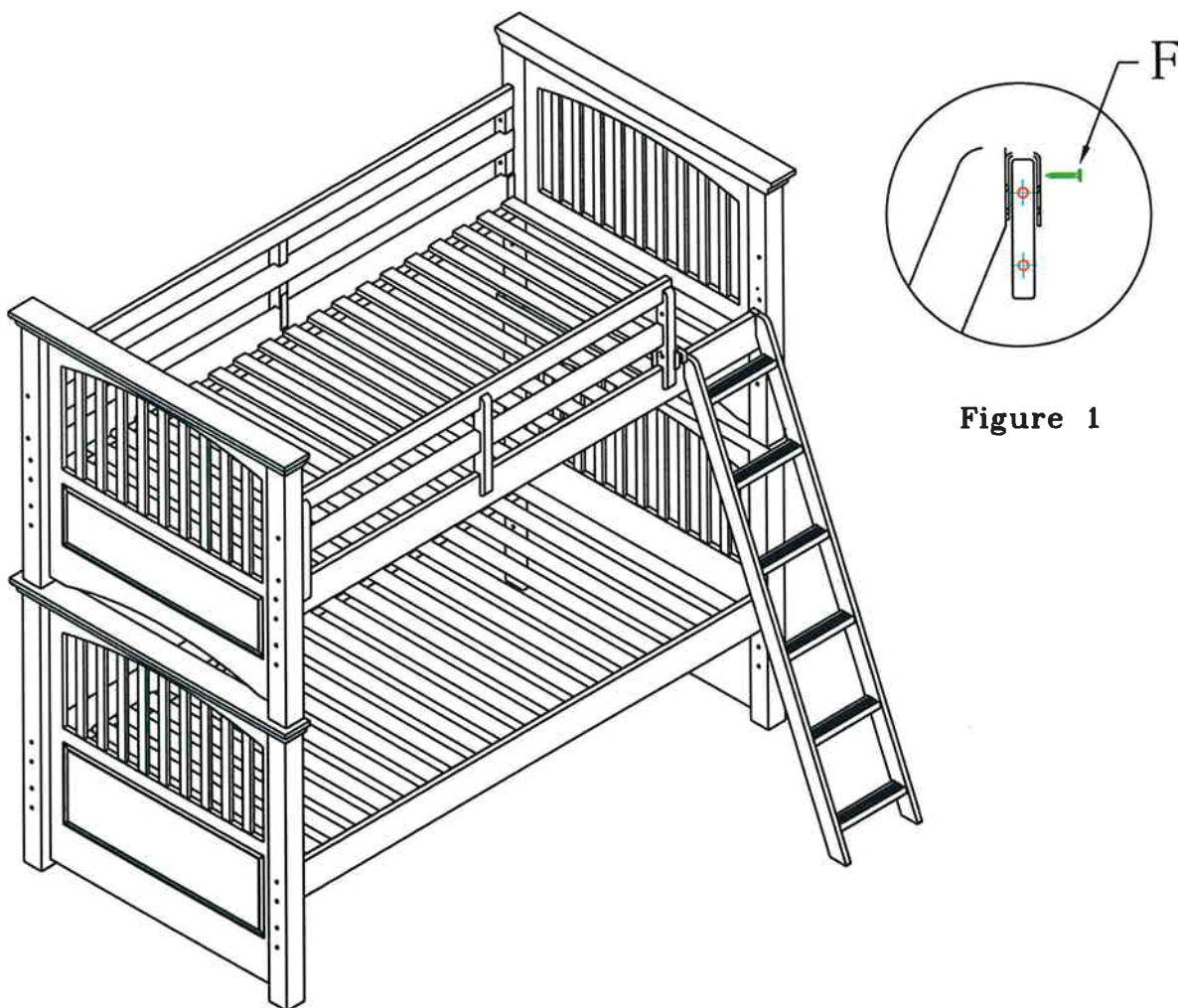

Figure 1

Hardware Used In This Step

ID#		Qty
F	 3/4" Wood Screw	2

This step for use as 2 twin beds

1. You may assemble your bunk bed into 2 separate twin size beds.
 2. The taller bed ends are used as headboards and the shorter bed ends are used as footboards.
 - 3. 4 wood plugs are included for use on top of the bed posts.**
- Note: Make sure to turn the face of the headboard toward the mattress.

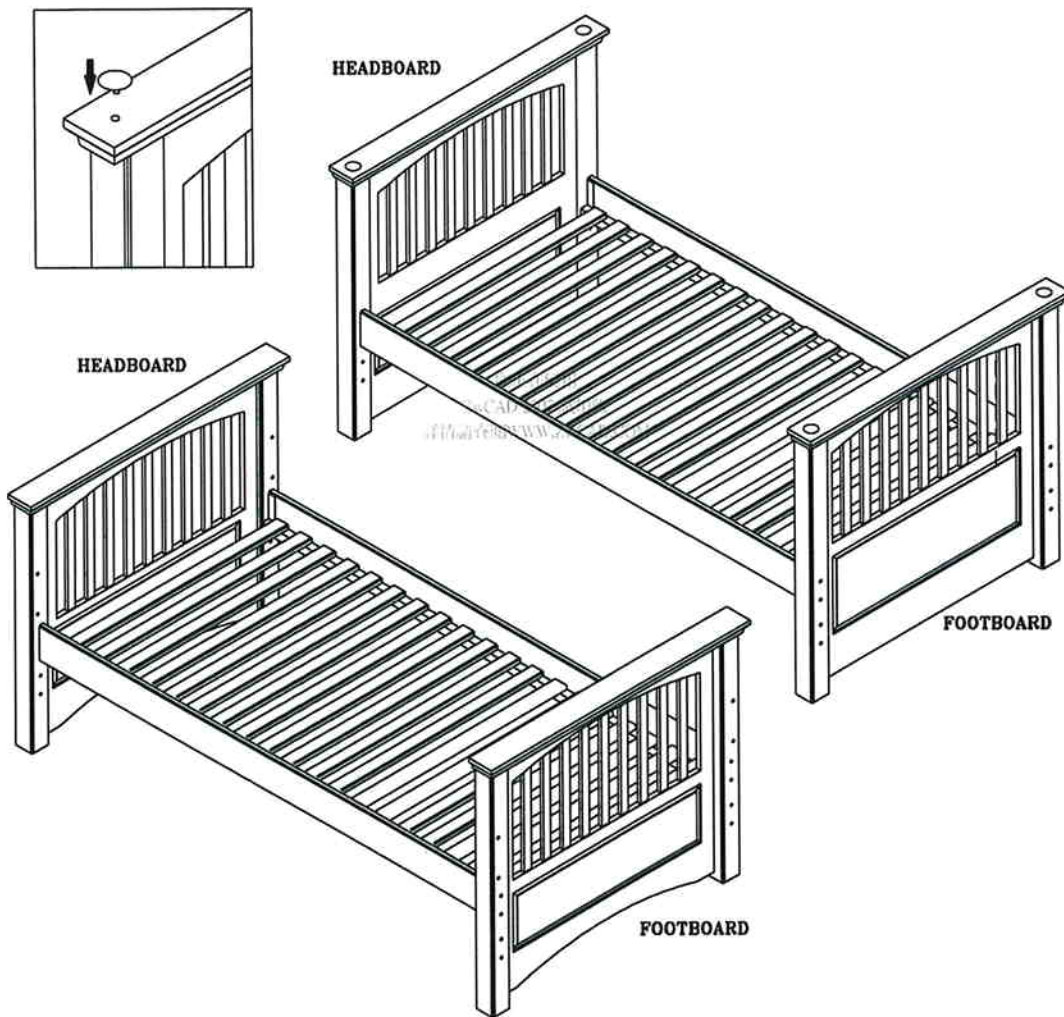

ID#		Qty
J	 Wood Plug for Top of Post	4

BEDDING SPECIFICATION

UPPER BUNK MATTRESS DIAGRAM

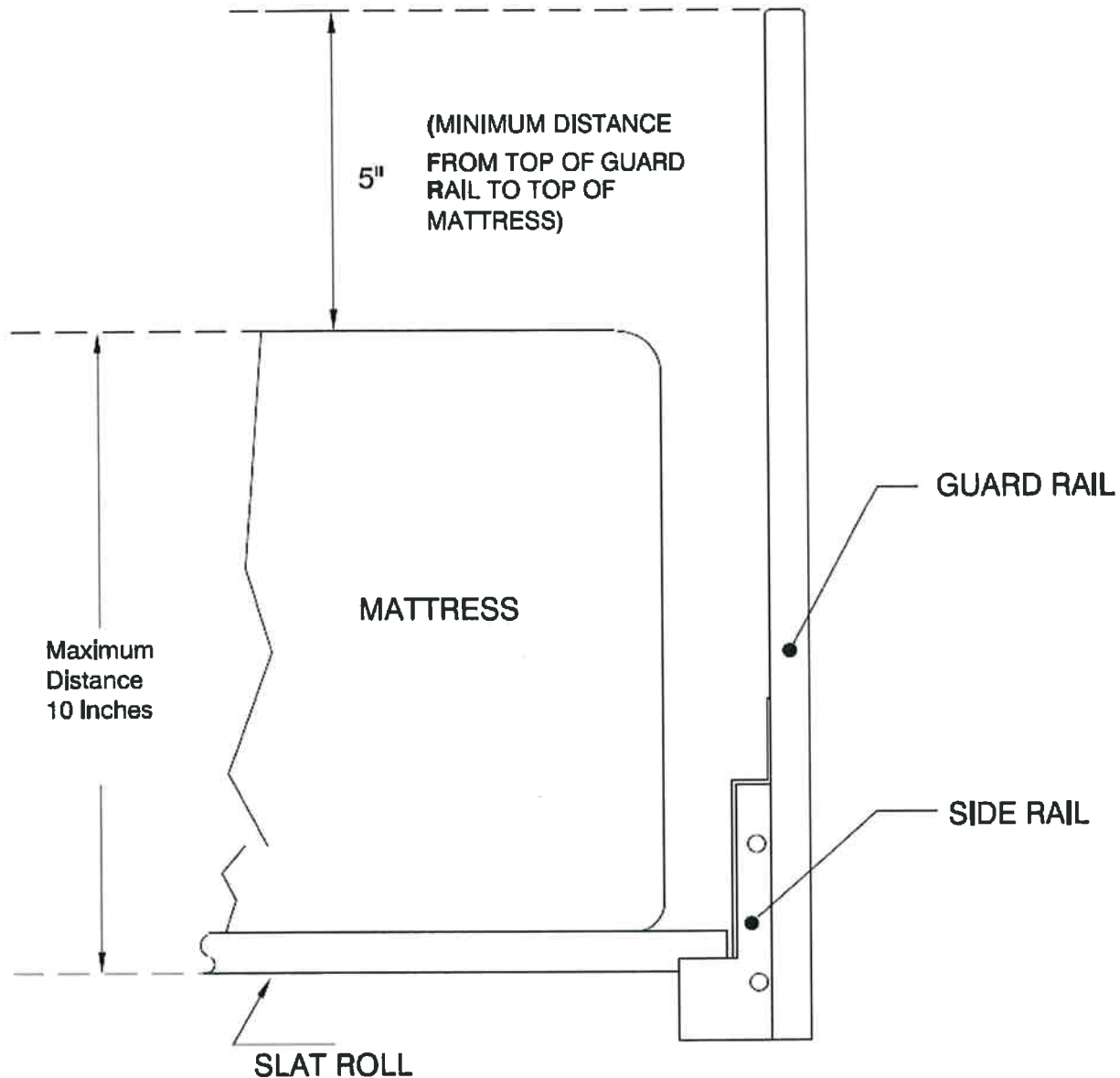

MATTRESS SIZES

Minimum Foundation & Mattress Size:
(37 1/2" x 74")

Maximum Foundation & Mattress
Thickness Combined:(10")



Assembly Instructions For #5140 Full Size Bunk Bed Extension Kit

Caution: (1) These parts are cumbersome and heavy. This product can best be assembled with the assistance of one or more persons in order to prevent personal injury and to insure parts are not damaged during the assembly process. Clean finished parts with mild dishwashing liquid and water solution applied on damp cloth. Cloth should not be excessively wet. Polish finish with soft cloth and an industry recognized furniture polish.

(2) To prevent damage to your floor or carpet, please check the bottom of each piece of furniture for stain residue and rough surfaces and also check for staples or nails left after removing the packaging material. The manufacturer will not be held responsible if preventative steps are not taken prior to installation.

(3) This extension kit is designed to work on the bottom bunk only! DO NOT ATTEMPT TO ATTACH TO UPPER BUNK!

This bunk bed is designed for the following size mattress and foundation on lower bed:

Mattress: 53" x 74 1/2" x 7" Maximum thickness

Bunkie board : 53" x 74 1/2" x 2"

Note: Mattress and mattress foundation combined must not exceed 10" total thickness.

ID# A		Qty 8
# 3/4" Connecting Bolt		

ID# B		Qty 8
Hole Cover		

ID# C		Qty 1
4mm Hex Wrench		

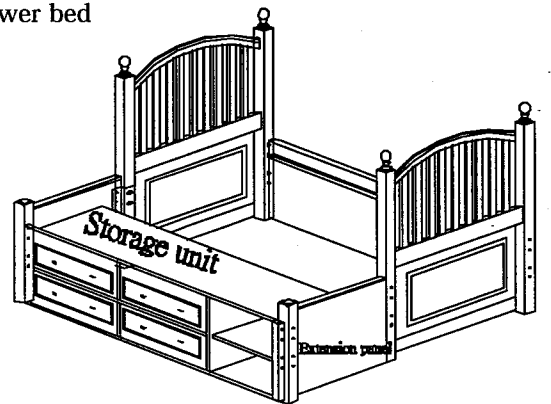
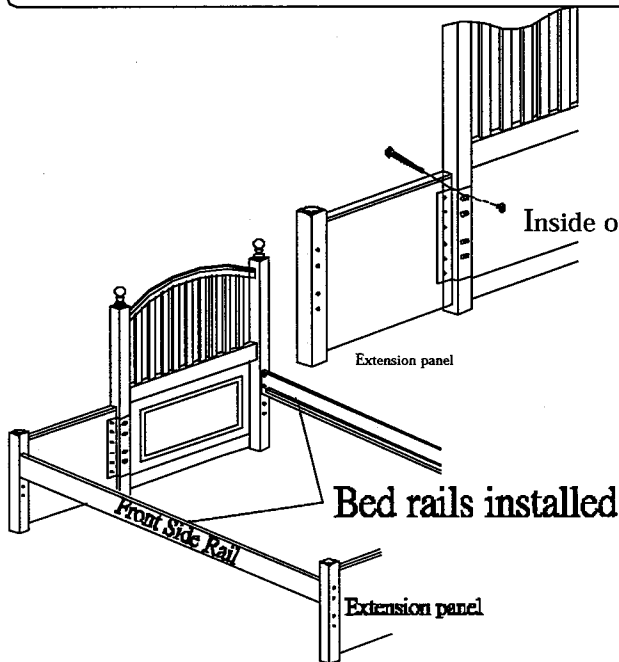

Optional storage unit installed

Note: When attaching #5140 extension kit to an existing bunk bed: Remove slats between rails of bottom bunk and front side rail prior to assembly of extension kit.

Step 1: Bunk bed must be assembled prior to extension kit assembly.

Step 2: Position extension panel bracket to lower bed post, aligning slots in bracket with holes in bed post.

Step 3: Insert hole cover (B) through slots in bracket and into holes in bed post, Place bolts (A) through post from outside. Tighten the 4 bolts (A) with the wrench (C).

Step 4: Repeat step (4) on other end.

Step 5: After attaching extension panels, attach side rail with 4.1/2" connecting bolts. Note: Also you can attach optional storage unit (#9100) with 3.1/2" connecting bolts if you wish.

Step 6: Install the longer slats roll purchased with #5140 extension kit, use wood screws provided, between the bottom side rails. See slat roll assembly instruction.

Step 7: Attach the slat roll in the same manner as shown on the bunk bed assembly instructions .