

QUICK REFERENCE GUIDE



TACOMA

2022

2022

TACOMA

This Quick Reference Guide is a summary of basic vehicle operations. It contains brief descriptions of fundamental operations so you can locate and use the vehicle's main equipment quickly and easily.

The Quick Reference Guide is not intended as a substitute for the Owner's Manual located in your vehicle's glove box. We strongly encourage you to review the Owner's Manual and supplementary manuals so you will have a better understanding of your vehicle's capabilities and limitations.

Your dealership and the entire staff of Toyota Motor North America, Inc. wish you many years of satisfied driving in your new Tacoma.

A word about safe vehicle operations

This Quick Reference Guide is not a full description of Tacoma operations. Every Tacoma owner should review the Owner's Manual that accompanies this vehicle.

Pay special attention to the boxed information highlighted in color throughout the Owner's Manual. Each box contains operating instructions to help you avoid injury or equipment malfunction.

All information in this Quick Reference Guide is current at the time of printing. Toyota reserves the right to make changes at any time without notice.

INDEX

OVERVIEW

Engine maintenance	9
Fuel tank door release and cap	8
Hood release	8
Indicator symbols	4-5
Instrument cluster	4
Instrument panel	2-3
Instrument panel light control	8
Keyless entry ^{1,2}	6
Smart Key system ^{1,2}	7

FEATURES & OPERATIONS

Active traction control	26
Air conditioning/heating	23
Audio	18
Auto lock/unlock ^{1,2}	20
Automatic transmission	10
Blind Spot Monitor with Rear	
Cross Traffic Alert (BSM w/RCTA)	27
Clock	24
Clutch start cancel switch	13
Crawl Control	12
Door locks	24
Four-wheel drive	11
Garage door opener (HomeLink [®]) ³	18
Heated seats	24
Intuitive parking assist ^{1,2}	28
Lights ^{1,2} & turn signals	16-17
Manual transmission	11
Moonroof	22
Multi-Information Display (MID) ^{1,2}	22
Multi-terrain select	12
Odometer and trip meter	13
Parking brake	28
Power outlet-12V DC	25
Power outlet-120V AC	25
Power Sliding Rear window	28
Power windows	17
Qi Wireless charger	21
Rear differential lock	27

FEATURES & OPERATIONS (continued)

Rear seats-Folding	15
Rear view monitor system	29
Seat adjustments-Front	14
Seats-Head restraints	14
Steering lock release	29
Steering wheel switches & telephone controls (Bluetooth [®])	19
Tilt and telescopic steering wheel	13
Trailer lights	25
USB charge ports	20
USB media port	20
Vehicle Stability Control (VSC)/TRAC/Trailer sway control OFF switch	26
Windshield wipers & washers	17

TOYOTA SAFETY SENSE™ P (TSS-P)

Automatic High Beams (AHB)	40
Dynamic Radar	
Cruise Control (DRCC)	37-39
Lane Departure Alert (LDA)	33-36
Pre-Collision System with Pedestrian Detection (PCS w/PD)	31-33
Quick overview-	
Toyota Safety Sense™ P (TSS-P)	30
Sensors	30

SAFETY & EMERGENCY FEATURES

Floor mat installation	45
Rear door child safety locks	42
Safety Connect [®]	41
Seat belts	41
Seat belts-Shoulder belt anchor	41
Spare tire & tools	43
Star Safety System™	44-45
Tire Pressure Monitoring (warning) System (TPMS)	42

BLUETOOTH® DEVICE PAIRING SECTION

46-48

¹ Visit your Toyota dealer for information on customizing this feature.

² Programmable by customer. Refer to the Owner's Manual for instructions and more information.

³ HomeLink[®] is a registered trademark of Genex Corporation.

Instrument panel

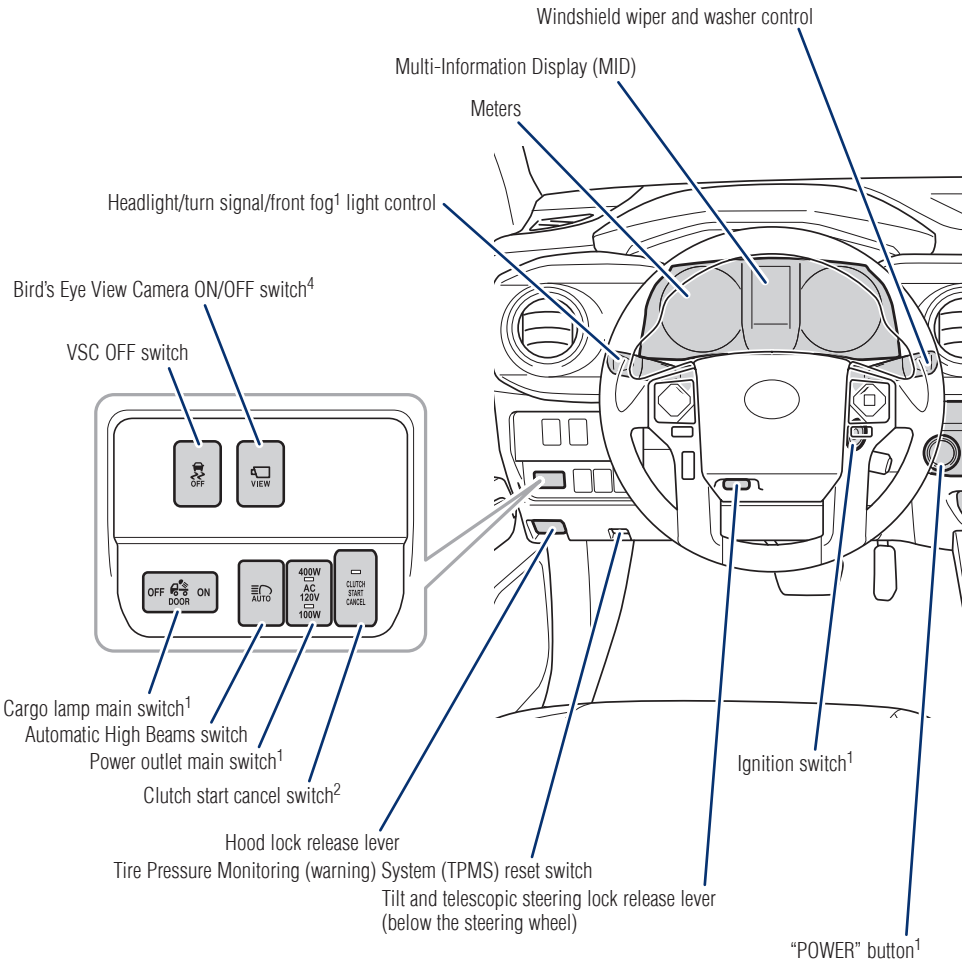
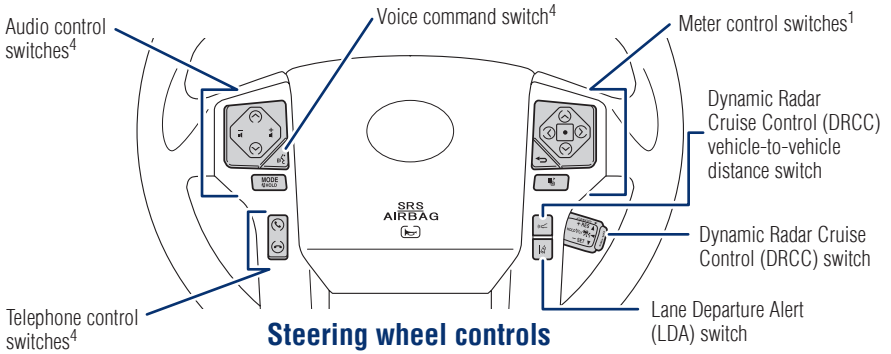

¹ If equipped.

² Manual transmission only.

³ Automatic transmission only.

⁴ For details, refer to the "Navigation and Multimedia System Owner's Manual" or visit www.toyota.com/audio-multimedia for additional resources.

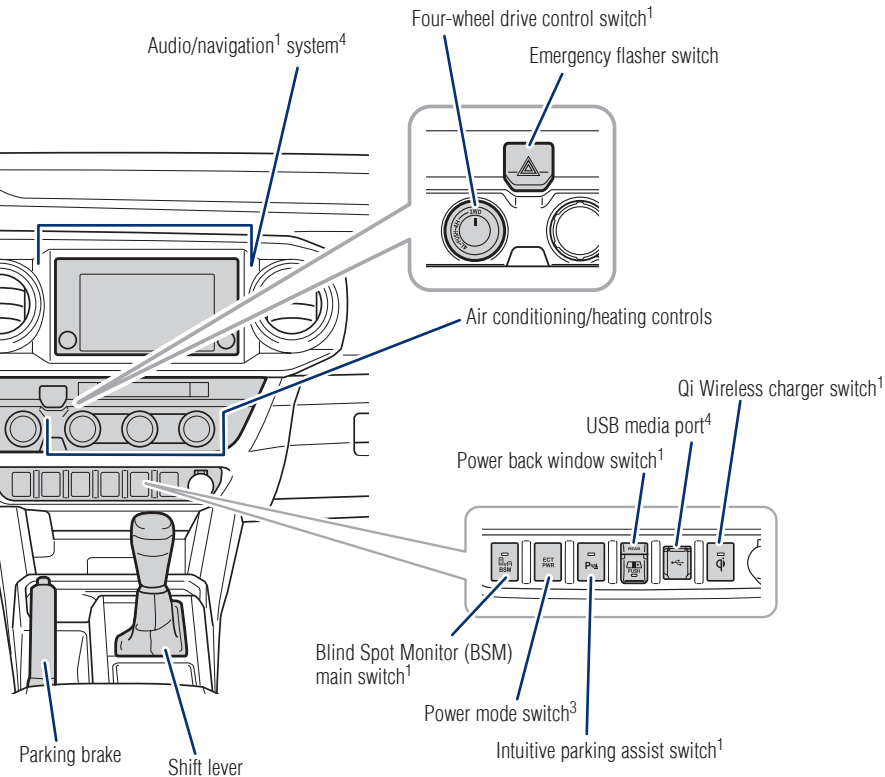

OVERVIEW

Instrument cluster

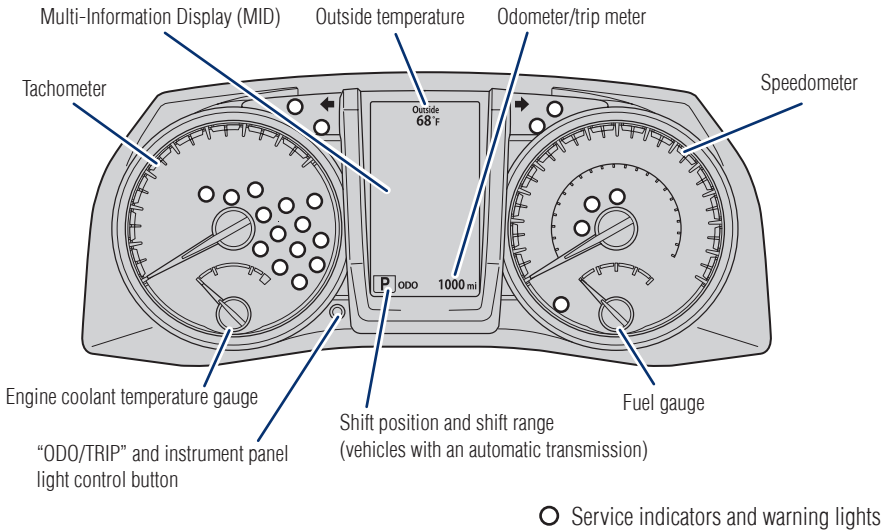

Indicator symbols

For details, refer to "Warning lights and indicators," Section 2, 2022 Owner's Manual.

- A-TRAC** Active traction control system indicator⁵
- AIR BAG ON/OFF** indicators¹
- Airbag SRS** warning¹
- ABS** Anti-lock Brake System (ABS) warning¹
- AUTO LSD** AUTO Limited Slip Differential) indicator¹
- AUTO** Automatic High Beams (AHB) indicator
- A/T OIL TEMP** Automatic transmission fluid temperature warning
- BSM** Blind Spot Monitor (BSM) outside rear view mirror indicators⁵
- Brake Override System/Drive-Start Control** warning
- BRAKE** Brake system warning¹
- Charging system** warning
- Constant speed cruise control/ Dynamic Radar Cruise Control (DRCC)** indicator
- SET** Constant speed cruise control/ Dynamic Radar Cruise Control (DRCC) SET indicator
- Crawl control** indicator⁵



Driver and/or front passenger seat belt reminder (alarm will sound when the vehicle is on)



Malfunction/Check Engine indicator¹



Fog light indicator⁵



Master warning^{1,2}



Four-wheel drive indicator (4WD models)



Multi-terrain select indicator⁵



Fuel tank door position



Parking brake indicator



Headlight low/high beam indicators



Power mode indicator (Automatic transmission only)



High coolant temperature warning



Pre-Collision System (PCS) warning^{1,2}



Lane Departure Alert (LDA) indicator [green/yellow⁴ indicator]



Rear differential lock indicator^{1,3,5}



Low engine oil level warning light



Security indicator⁵



Low engine oil pressure warning



Slip indicator^{1,4}



Low fuel level warning



Traction control (TRAC) OFF indicator¹



Low outside temperature indicator



Turn signal indicator



Low speed four-wheel drive indicator (4WD models)²



Vehicle Stability Control (VSC) OFF indicator¹



Low tire pressure warning¹

¹ If the indicator does not turn off within a few seconds of starting the engine, there may be a malfunction. Have the vehicle inspected by your Toyota dealer.

² If the indicator flashes, there may be a malfunction. Refer to the Owner's Manual.

³ If the indicator flashes rapidly, there may be a malfunction. Refer to the Owner's Manual.

⁴ If the indicator flashes, it indicates that the system is operating.

⁵ If equipped.

OVERVIEW

Keyless entry (if equipped)

UNLOCKING OPERATION



NOTE: If a door is not opened within 60 seconds of unlocking, all doors will relock for safety.

LOCKING OPERATION



PANIC BUTTON

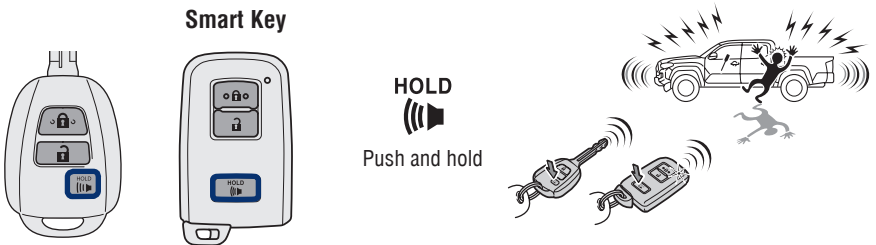

* Grasping front passenger door handle will unlock all doors.

Please refer to the Owner's Manual for more details.

NOTE: Doors may also be locked/unlocked using the mechanical key (vehicle with a Smart Key system.)

Smart Key system (if equipped)

START FUNCTION

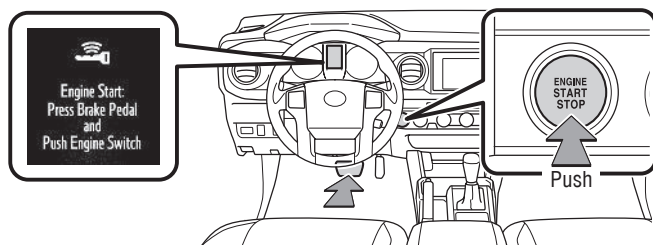

NOTE: The Smart Key must be carried to enable the start function. With the shift lever in Park and the brake pedal depressed, push the power button.

POWER (WITHOUT STARTING ENGINE)

Without depressing the brake pedal, pressing the power button will change the operation mode in succession from:

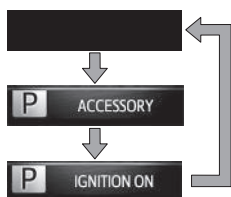

Off - All systems OFF. Emergency flashers can be used.

Accessory – Some electrical components can be used.

On - All electrical components can be used.

OVERVIEW

Fuel tank door release and cap

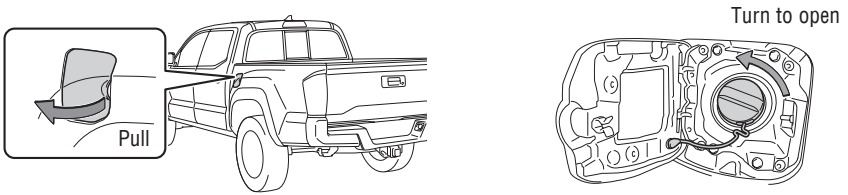

NOTE: Tighten until one click is heard. If the cap is not locked or tightened enough, the Check Engine indicator “” may illuminate.

Hood release

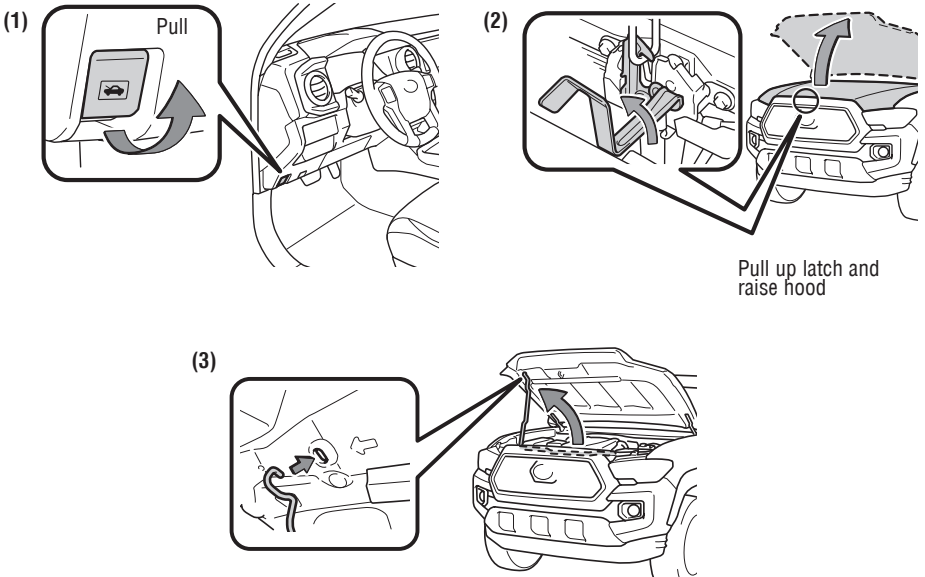

Instrument panel light control

Brightness control

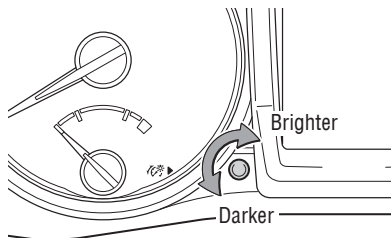

Engine maintenance

4 CYLINDER (2TR-FE) ENGINE

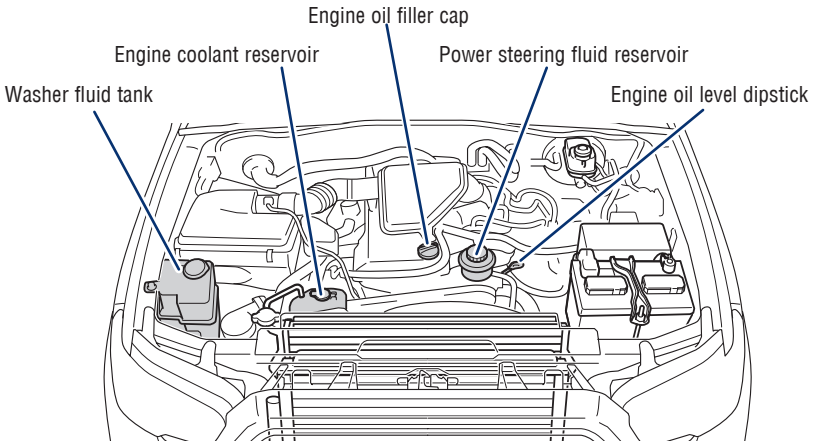

6 CYLINDER (2GR-FKS) ENGINE

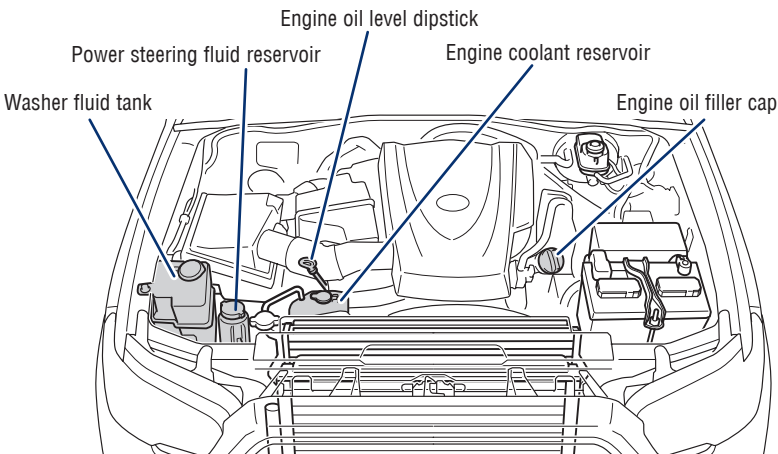

NOTE: Regularly scheduled maintenance, including oil changes, will help extend the life of your vehicle and maintain performance. Please refer to the “Warranty & Maintenance Guide.”

Automatic transmission (if equipped)

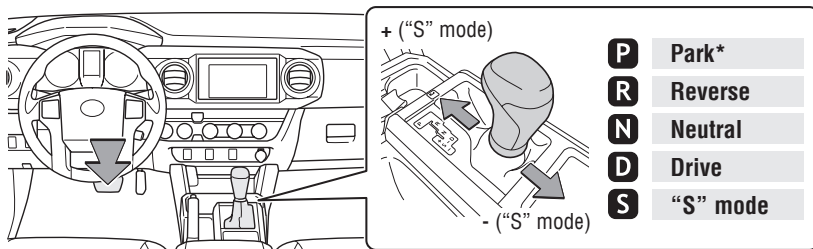

* The vehicle must be on and the brake pedal depressed to shift from Park.

"S" MODE

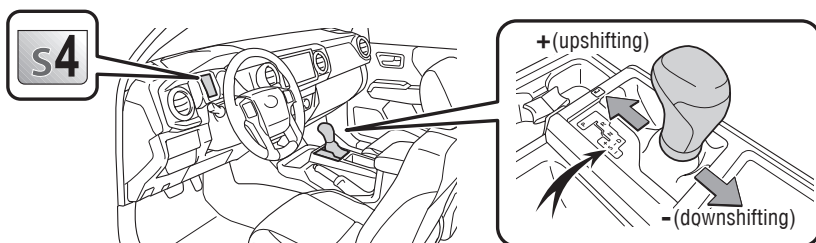

The initial shift range in "S" mode is set automatically to 5 or 4 according to vehicle speed.

Selecting shift ranges using "S" mode restricts the upper limit of the possible gear ranges, controls engine braking forces and prevents unnecessary upshifting.

Shift the shift lever to "S" position from "D" position.

- + : Upshift (push and release)
- : Downshift (pull and release)

Downshifting increases power going uphill, or provides engine braking downhill. For best fuel economy during normal driving conditions, always drive with the shift lever in the "D" position.

POWER MODE

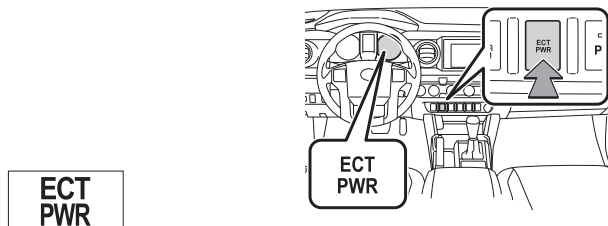

Use when high levels of response and feeling are desirable, such as when driving in mountainous regions or when pulling a trailer.

Manual transmission (if equipped)

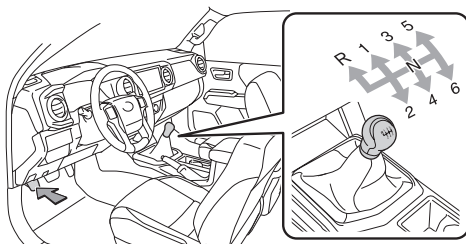

Four-wheel drive (if equipped)

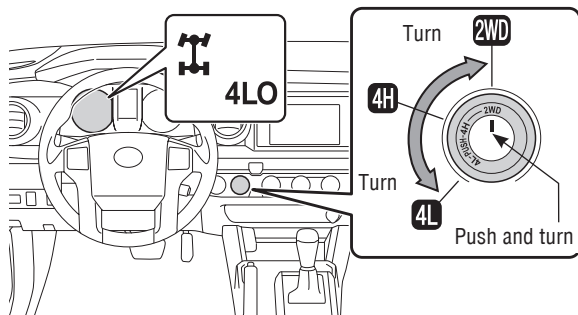

2WD **High speed (2WD)** Normal driving on dry hard-surfaced roads.

4H **High speed (4WD)**
For driving only on roads that permit the tires to slide, like off-road, icy or snow-covered roads.

4L **Low speed (4WD)**
For maximum power and traction when climbing or descending steep hills, off-road driving, and hard pulling in sand, mud or deep snow.

NOTE: For best fuel economy and performance under normal driving conditions, keep in “2WD” position.



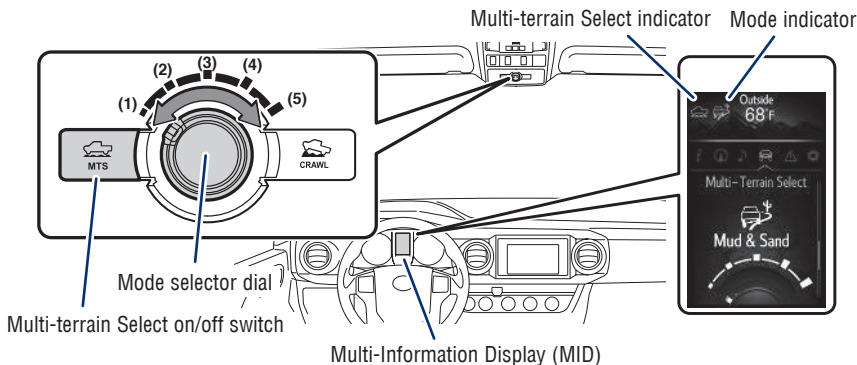

Refer to the Owner's Manual for more information.

Multi-terrain select (if equipped)



Improves driveability in off-road situations. Select one of five modes that most closely matches the terrain on which you are driving. Brake control can be optimized in accordance with the selected mode.

5 modes

- | | | |
|---|--|---|
| (1)  Mud & Sand | (2)  Loose Rock | (3)  Mogul |
| (4)  Rock & Dirt | (5)  Rock | |

Refer to the Owner's Manual for more information.

Crawl Control (if equipped)

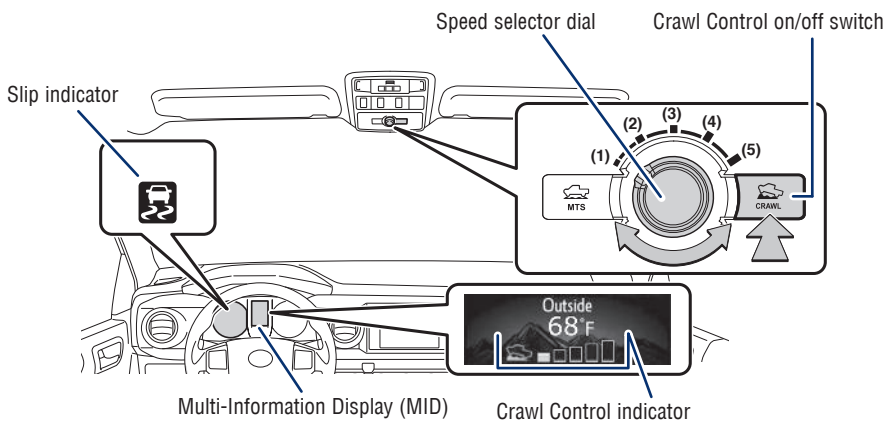

- (1) **Low to (2) Between low and medium** - Rock, mogul (downhill) and gravel (downhill)
- (2) **Between low and medium to (3) Medium** - Mogul (uphill)
- (3) **Medium to (5) High** - Snow, mud, gravel (uphill), sand, dirt, mogul (uphill) and grass

Allows travel on extremely rough off-road surfaces at a fixed low speed without pressing the accelerator or brake pedal.

Refer to the Owner's Manual for more information.

Clutch start cancel switch (if equipped)

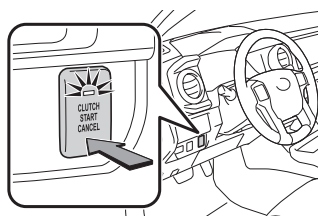

The vehicle must be in the "ON" position.

The clutch start cancel switch allows you to start the engine and drive out of difficult situations where the vehicle should not be allowed to roll backwards.

Refer to the Owner's Manual for more information.

Tilt and telescopic steering wheel

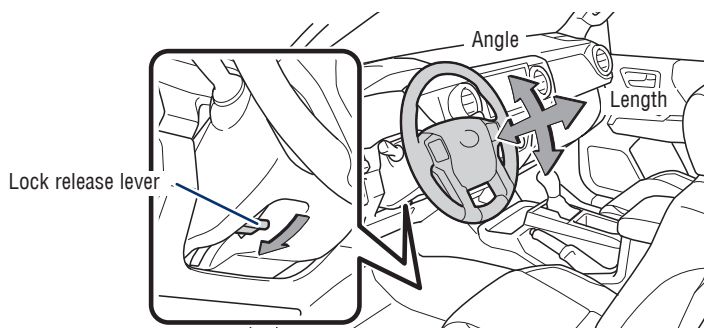

Hold the steering wheel, push the lever down, set angle and length, and return the lever.

NOTE: Do not attempt to adjust while the vehicle is in motion.

Odometer and trip meter

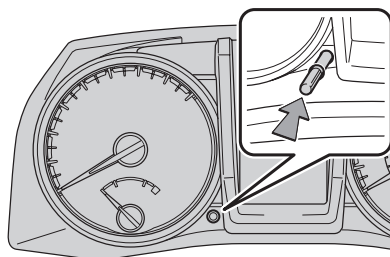

Push to switch display.

FEATURES & OPERATIONS

Seats-Head restraints

ACCESS CAB MODELS

Separate seats-Front Vertical adjustment

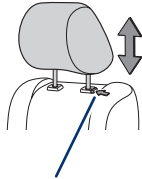

Lock release button

Separate-Rear Folding

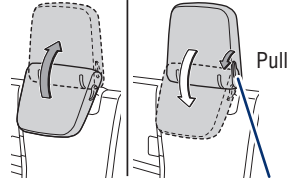

Lock release lever

DOUBLE CAB MODELS

Separate seats-Front Vertical adjustment

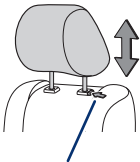

Lock release button

Center-Rear Vertical adjustment

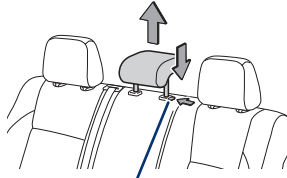

Lock release button

Outer-Rear Folding

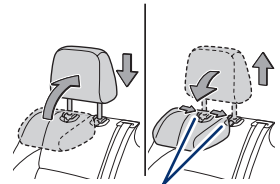

Lock release button

Seats adjustments-Front

MANUAL SEAT

POWER SEAT* (DRIVER'S SIDE ONLY)

*If equipped.

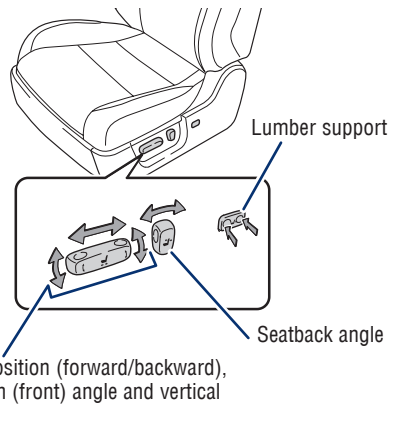
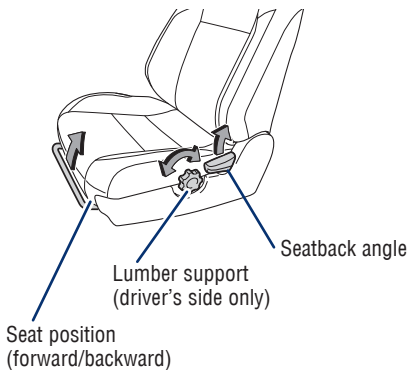

Rear seats-Folding

RAISING - ACCESS CAB MODELS

(1)

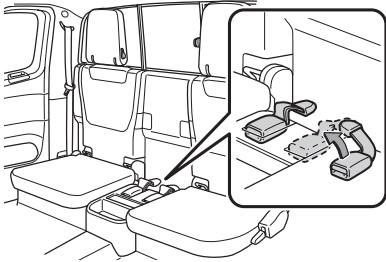

Stow the seat belt buckles.

(2)

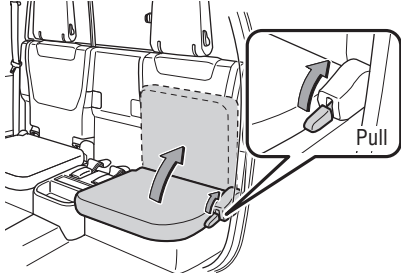

Raise the bottom cushion up while pulling the lever until it locks.

FOLDING - DOUBLE CAB MODELS

(1)

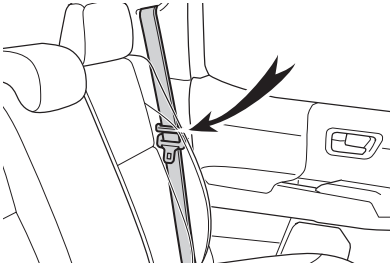

Pass the seat belt through the seat belt hangers.

(2)

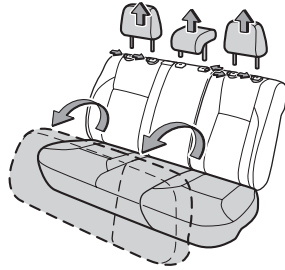

Remove head restraints and lift up the bottom cushion.

(3)

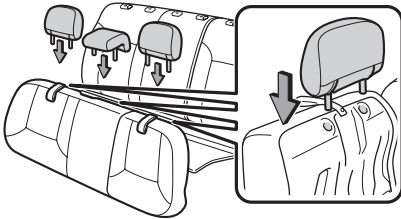

Attach the head restraints.

(4)

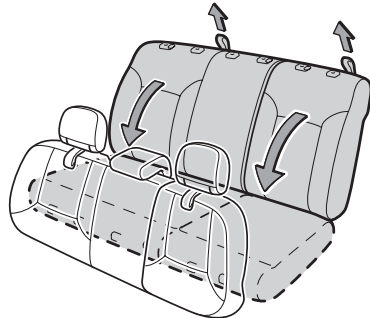

Pull lock release strap and fold down the seatback.

Lights & turn signals

HEADLIGHTS

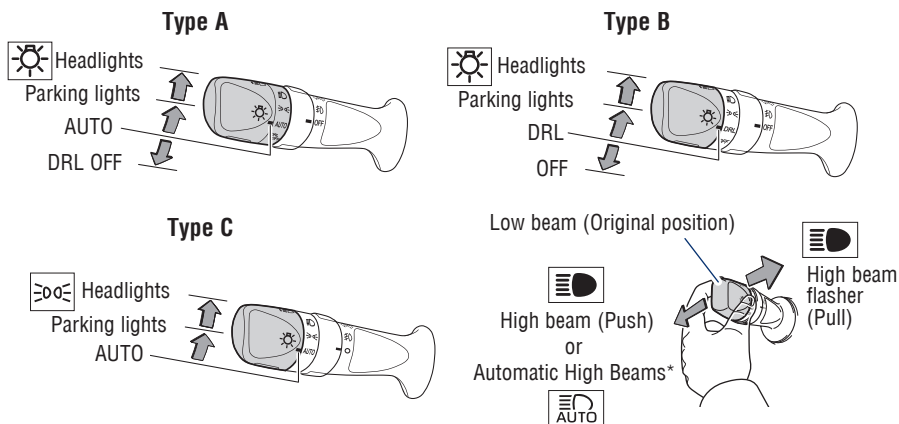

Daytime running light (DRL) system Automatically turns on under certain conditions to make vehicle more visible to other drivers. Not for use at night.

Automatic light cut off system

- Headlights are in "AUTO" or "AUTO": The lights will turn off automatically 30 seconds after the vehicle is turned from ON to "LOCK" position** or OFF*** and a door is opened and all of the doors are closed. (If the lock switch on the Smart Key remote is pushed after all doors are closed, the lights will turn off immediately.)
- Headlights are in "": The lights will turn off automatically if the vehicle is turned from ON to "LOCK" position** or OFF*** and the driver's door is opened.

Automatic High Beams (AHB) system Automatically switches between high and low beams as appropriate to enhance vision at night.

Refer to Toyota Safety Sense™ P (TSS-P) in this guide or the Owner's Manual for more details on the Automatic High Beams feature.

* Operating conditions must be met. Refer to the Owner's Manual for details.

** Vehicle equipped without a Smart Key system.

*** Vehicle equipped with a Smart Key system.

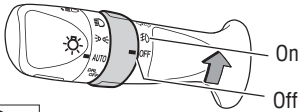

Front fog lights come on when the parking lights are on or the headlights are on in low beam.

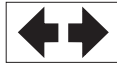
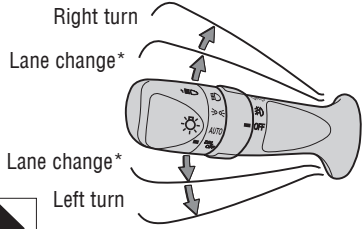

* Move lever partway and release. The signals will flash three times.

Power windows

Driver side

Type A (driver's side only)

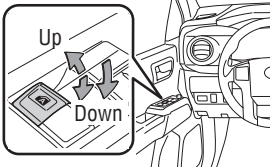

Type B (front seat windows)

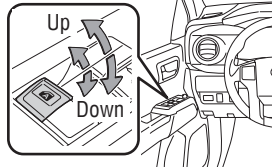

Window lock switch

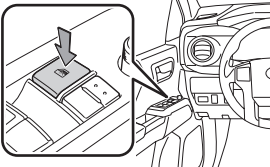

Automatic down (type A)/up or down (type B) operation Push the switch completely down or pull it completely up and release to fully open or close. To stop the window partway, operate the switch in the opposite direction.

Window lock switch Deactivates all passenger windows. Driver's window remains operable.

Windshield wipers & washers

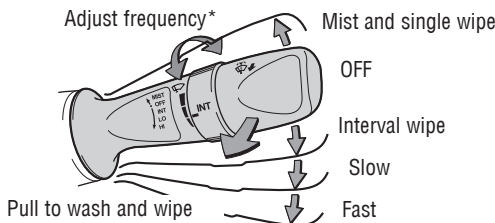

* **Intermittent windshield wiper frequency adjustment:** Rotate to increase/decrease wiper frequency.

FEATURES & OPERATIONS

Audio

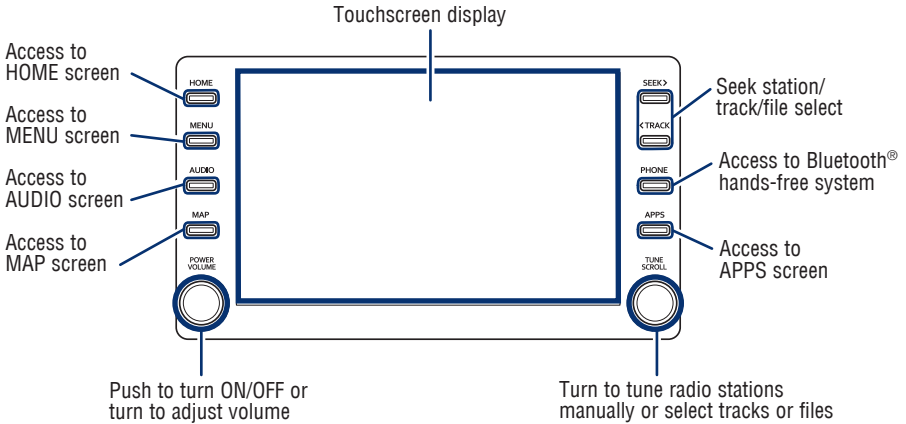

Refer to the “Navigation and Multimedia System Owner’s Manual” or visit www.toyota.com/audio-multimedia for additional resources.

NOTE: Always use safe driving practices and follow all traffic rules.

Garage door opener (HomeLink®*) (if equipped)

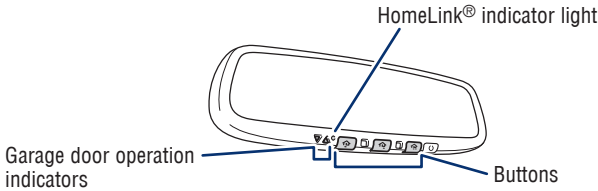

Garage door openers manufactured under license from HomeLink®* can be programmed to operate garage doors, estate gates, security lighting, etc.

Refer to the Owner’s Manual for more details.

For programming assistance, contact HomeLink® at 1-800-355-3515, or visit <http://www.homelink.com/toyota>.



* HomeLink® is a registered trademark of Gentex Corporation.

Steering wheel switches & telephone controls (Bluetooth®)

“ ^ v ” Use to search within the selected audio feature.

“MODE/HOLD” Push to change audio mode. Push and hold to mute or pause the audio.

Start call

End call

Volume controls

Voice command switch

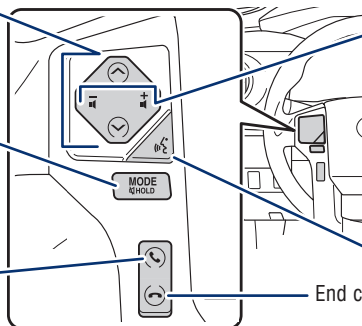

Type A (without moonroof)

Microphone

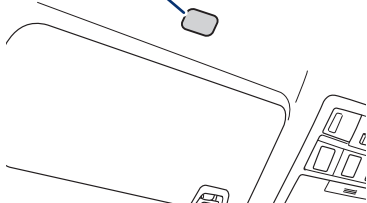

Type B (with moonroof)

Microphone

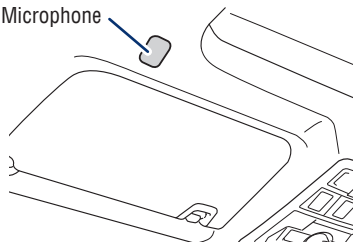

Bluetooth® technology allows dialing or receipt of calls without removing your hands from the steering wheel.

Refer to the Bluetooth® device pairing in this guide or the Navigation and Multimedia System Owner's Manual for additional user instructions.

NOTE: Always use safe driving practices and follow all traffic rules.

FEATURES & OPERATIONS

USB media port

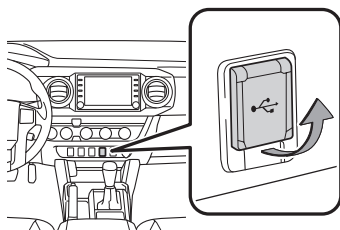

Connecting a compatible device and cable into the USB media port will support charging and music playback through the audio multimedia system.

USB charge ports

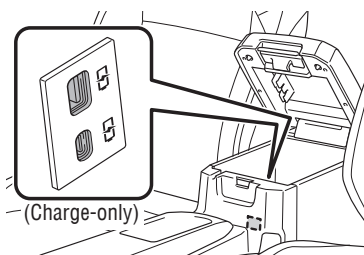

The vehicle must be in the "ACC" or "ON" position (without Smart Key) / "ACCESSORY" or "IGNITION ON" mode (with Smart Key) for use.

Auto lock/unlock

Automatic door locks can be programmed to operate in different modes, or turned OFF. (It is available only on vehicles with automatic transmissions.)

DEFAULT SETTING

Shift position linked door unlocking function

-Doors unlock when shifting into Park.

Speed linked door locking function

-Doors lock when the vehicle speed is approximately 12 mph (20 km/h) or higher.

CUSTOMIZED SETTING

Shift position linked door locking function

-Doors lock when shifting from Park.

Driver's door linked door unlocking function

- (Without a Smart Key) Doors unlock when the driver's door is opened within 10 seconds after turning the ignition switch to the "LOCK" position.
- (With a Smart Key) Doors unlock when the driver's door is opened within 10 seconds after turning the vehicle off.

Refer to the Owner's Manual for more details.

Qi Wireless charger (if equipped)

Charging can only be performed with the vehicle in the “ACC” or “ON” position (without Smart Key)/ ACCESSORY or IGNITION ON mode (with Smart Key) and only on mobile devices with the “Qi” logo.

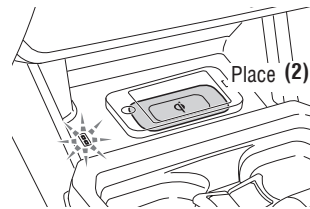
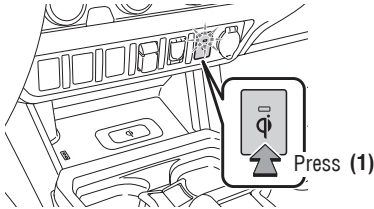

Place device nearest in the center of charging area for best results. Moving device may result in stopping or restarting the charging process.

A mobile device can be charged wirelessly on the tray. **(1)** Press the wireless charger power switch. **(2)** Place a compatible mobile device on the tray as shown in the illustration. An amber indicator illuminates while charging is in progress. When charging is complete, the indicator illuminates green. Some phones, cases or cover type wireless chargers may not cause the green indicator to illuminate even though it is fully charged.

Refer to the Owner's Manual for limitations and more details on this system before attempting to use it.

Multi-Information Display (MID)

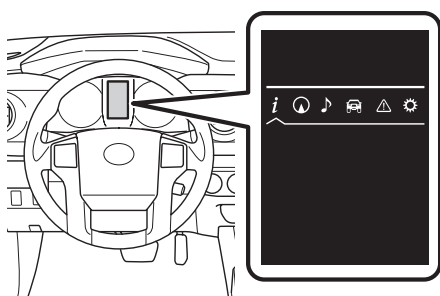

Enter/Set:
Press to enter/set,
press and hold to
reset

“◊” and “<>”
Press to select an item/change
pages

Return to the
previous screen

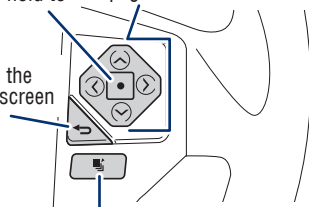

Switch menus/Display top screen

Press meter control switches to change and select information in the following:



Drive information



Navigation system-linked display (if equipped)



Audio system-linked display



Vehicle information (if equipped)



Warning message display



Settings display

Refer to your Owner's Manual for complete details.

Moonroof (if equipped)

SLIDING OPERATION

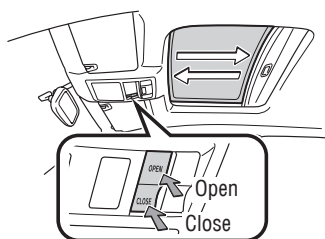

Push once to open completely.

TILTING OPERATION

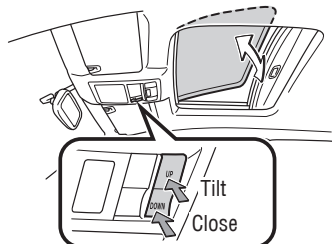

Push once to open completely.

Lightly press either side of the moonroof switch while opening/tilting is in progress, the moonroof stops partway.

Air conditioning/heating

AUTOMATIC AIR CONDITIONING (IF EQUIPPED)

Display

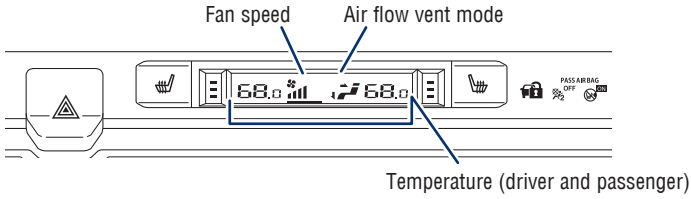

Selectors and switches

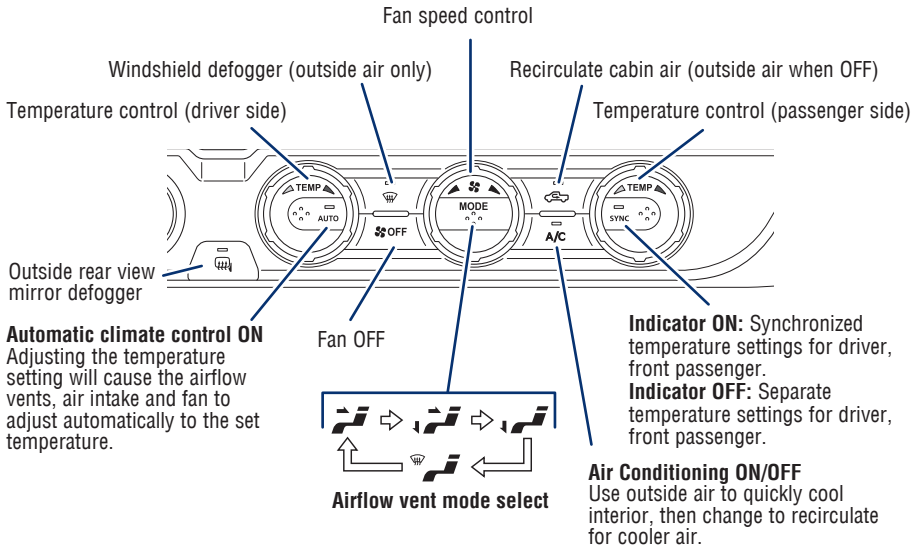

MANUAL AIR CONDITIONING (IF EQUIPPED)

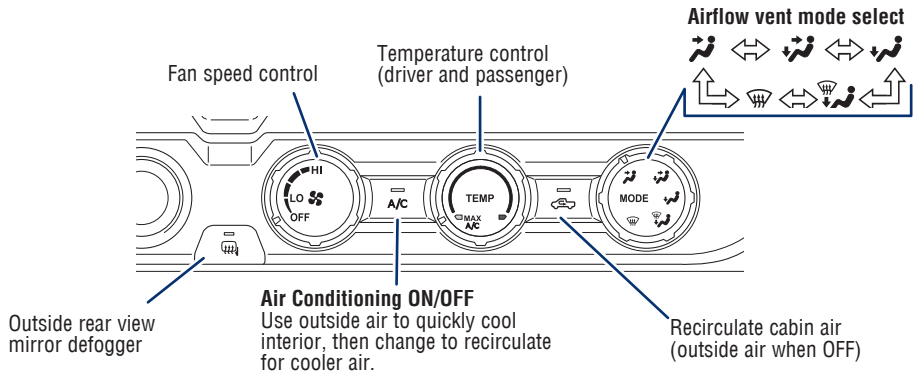

FEATURES & OPERATIONS

Heated seats (if equipped)

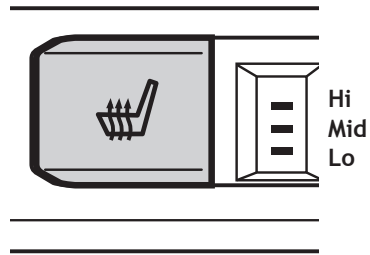
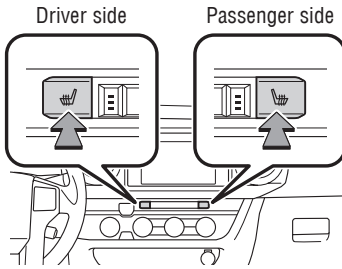

Press to **Hi (ON)**>**Mid**>**Lo**>**OFF**

The vehicle must be on for use.

Clock

Select to change the time zone.

Select to set daylight saving time ON/OFF/AUTO*.

Select to set automatic adjustment of the clock by GPS on/off.

Select to set the 24 hour time format on/off.

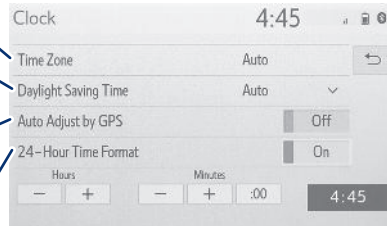

- 1) Push "**MENU**" button next to the screen.
- 2) Select "**Setup**" or "**General**" in the touchscreen to access the general setting screen.
- 3) Select "**Clock**."
- 4) Select the desired items to be set.

Refer to the "Navigation and Multimedia System Owner's Manual" for more details.

* Premium Audio only

Door locks

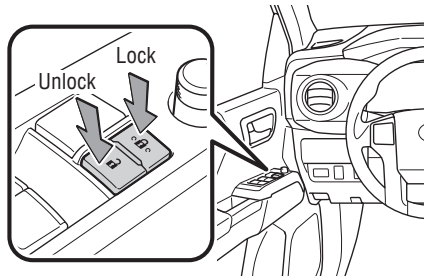

Power outlet-12V DC

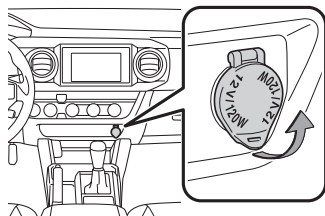

The vehicle must be in the "ACC" or "ON" position (without Smart Key) / "ACCESSORY" or "IGNITION ON" mode (with Smart Key) for use.

Power outlet-120V AC (if equipped)

Main switch

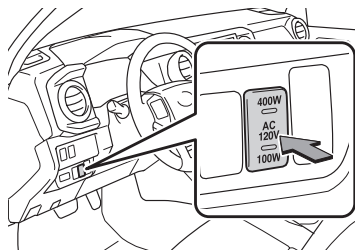

120 V AC/400 W



120 V AC/100 W

Power outlet socket (deck)

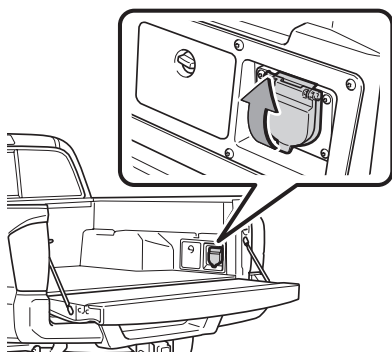

The power outlet can be used when the engine is running.

Refer to the Owner's Manual for more details.

Trailer lights

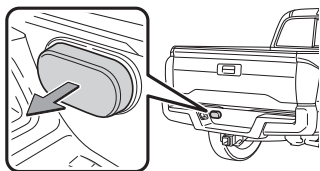

Use wire harness to connect trailer lights.

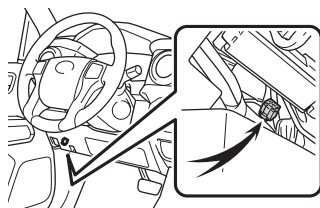

Use service connector for the trailer brake controller.
(With a towing package)

Refer to the Owner's Manual for more details.

FEATURES & OPERATIONS

Active traction control (if equipped)

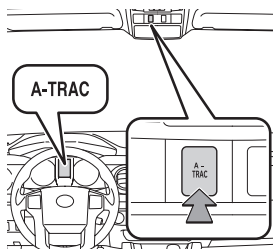

The active traction control system automatically helps prevent the spinning of four wheels when the vehicle is started or accelerated on slippery road surfaces.

Refer to the Owner's Manual for more information.

Vehicle Stability Control (VSC)/TRAC/ Trailer sway control OFF switch

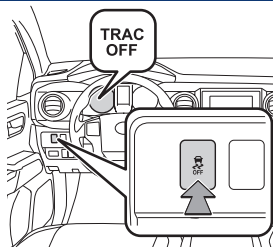
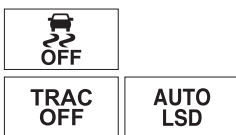

The VSC OFF switch is used to switch between modes related to the TRAC, VSC and Auto LSD functions.

To disable VSC/TRAC/Trailer Sway Control systems, press and hold the switch for at least 3 seconds.

Refer to the Owner's Manual for limitations and more information.

Rear differential lock (if equipped)

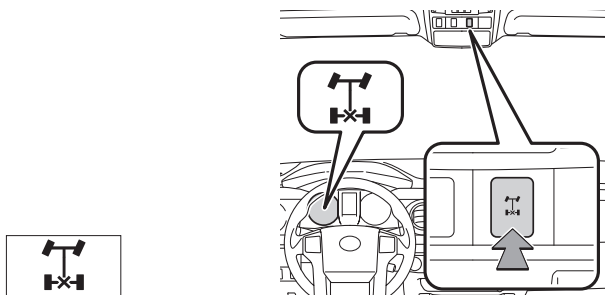

Use **ONLY** when wheel spinning occurs in a ditch, or on slippery or unpaved surfaces. **DO NOT USE THE REAR DIFFERENTIAL LOCK IN CONDITIONS OTHER THAN THOSE SPECIFIED IN THE OWNER'S MANUAL. UNLOCK THE DIFFERENTIAL ONCE THE VEHICLE MOVES OUT OF THE TROUBLE SPOT.**

Refer to your Owner's Manual for complete details on this system before attempting to use it.

Blind Spot Monitor with Rear Cross Traffic Alert (BSM w/RCTA) (if equipped)

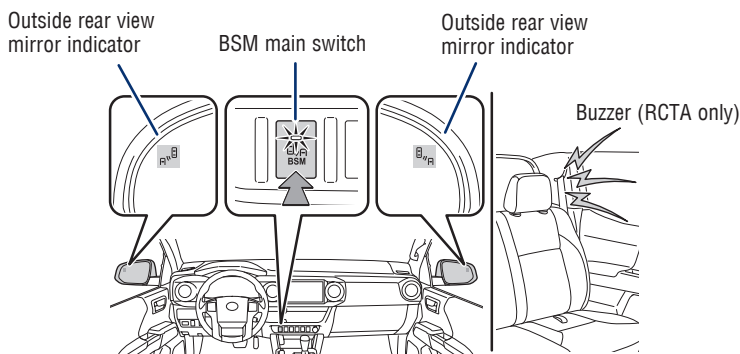

The Blind Spot Monitor is a system that has two functions:

- The Blind Spot Monitor function (assists the driver in making the decision when changing lanes)
- The Rear Cross Traffic Alert function (assists the driver when backing up)

The system is designed to use radar sensors to detect vehicles traveling in the Tacoma's blind spot. If a vehicle is detected, the driver will be alerted via the outside rear view side mirror indicators.

Rear Cross Traffic Alert function:

While in reverse, when a vehicle approaching from the right or left rear of the Tacoma is detected, the outside rear view mirror indicators will flash. Also, RCTA buzzer will sound.

Refer to the Owner's Manual for limitations and more details on this system before attempting to use it.

FEATURES & OPERATIONS

Power Sliding Rear window (if equipped)

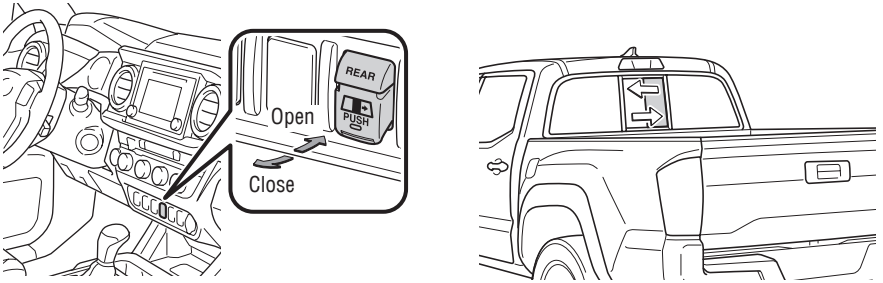

The vehicle must be on for use.

Intuitive parking assist (if equipped)

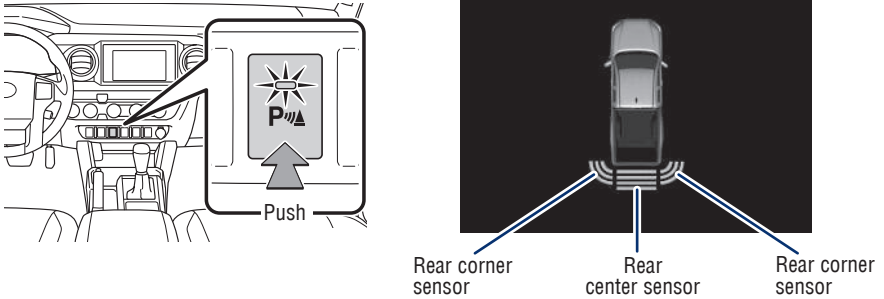

If the sensors detect an obstacle, the buzzer and MID inform the driver of the approximate position and distance of the obstacle by illuminating continuously (near) or blinking intermittently (far). Depending on your Audio Multimedia System, you can adjust settings.

Refer to the Owner's Manual for limitations and more details.

Parking brake

Set

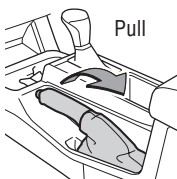

PARK

Release

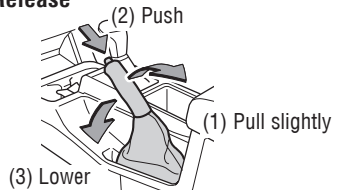

Rear view monitor system

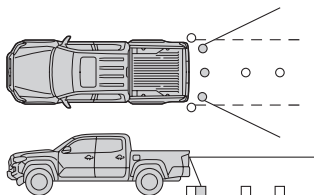

The rear view monitor system displays an image of the view from the bumper of the rear area of the vehicle. The camera for the rear view monitor system is integrated in the tailgate handle.

To adjust the image on the rear view monitor screen, press the "MENU" button and select "Display." Select "Camera" to adjust the screen contrast and brightness.

Refer to the Navigation and Multimedia System Owner's Manual for limitations and more details on this system.

Steering lock release

Without Smart Key system

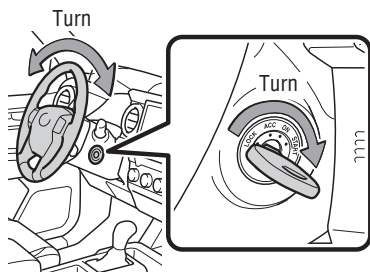

When starting the engine, the engine switch may seem stuck in the "LOCK" position. To free it, turn the key while turning the steering wheel slightly left and right.

With Smart Key system

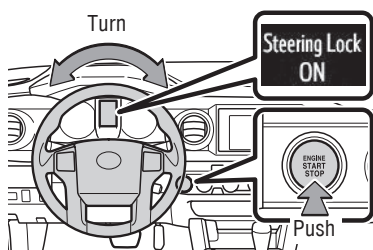

A message will be displayed on the Multi-Information Display (MID).

Check that the shift lever is in P. Press the power button while turning the steering wheel left and right.

Quick overview-Toyota Safety Sense™ P (TSS-P)

Toyota Safety Sense™ P (TSS-P) is a set of active safety technologies designed to help mitigate or prevent collisions across a wide range of traffic situations, in certain conditions. TSS-P is designed to help support the driver's awareness, decision making and vehicle operation contributing to a safe driving experience.

Refer to the Owner's Manual for operation, setting adjustments, limitations and more details to understand these functions and complete safety precautions. For more information, please go to www.toyota.com/safety-sense.



Pre-Collision System with Pedestrian Detection (PCS w/PD)

PCS w/PD is designed to provide alert, mitigation, and/or avoidance support in certain conditions, when the system detects a potential collision with a preceding vehicle is likely to occur.

The advanced grille-mounted radar system is designed to work with the forward-facing camera to help recognize a preceding pedestrian, and provide an alert, mitigation and/or avoidance support in certain conditions.



Lane Departure Alert (LDA)

LDA is designed to provide notification when the system detects an unintended lane departure.



Dynamic Radar Cruise Control (DRCC)

DRCC is designed to help maintain a pre-set distance to a preceding vehicle when the preceding vehicle is traveling at a lower speed.



Automatic High Beams (AHB)

AHB is designed to detect the headlights of oncoming vehicles and the tail lights of preceding vehicles and switch between high beams and low beams as appropriate.

Sensors

TSS-P combines a forward-facing camera mounted in front of the inside rear view mirror and a grille-mounted radar mounted in the front grille. These sensors support the driver assist systems.

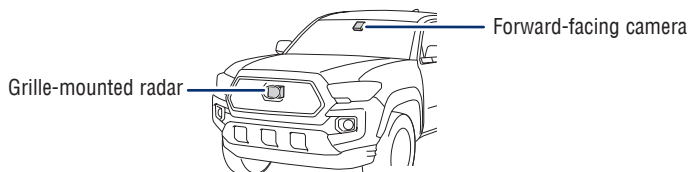

Pre-Collision System with Pedestrian Detection (PCS w/PD)

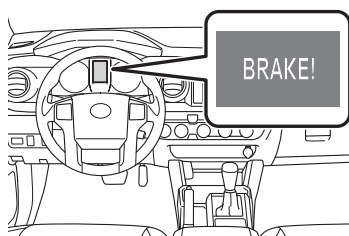

The Pre-Collision System with Pedestrian Detection (PCS w/PD) is designed to help detect a vehicle or a pedestrian in certain situations. Using a combination of a camera and radar, PCS w/ PD can provide an audio/visual alert to warn you of a possible collision under certain circumstances. If you don't react, the system is designed to automatically brake.

As there is a limit to the degree of recognition accuracy and control performance that this system can provide, do not overly rely on this system. This system will not prevent collisions or lessen collision damage or injury in every situation. Do not use PCS instead of normal braking operations under any circumstances. Do not attempt to test the operation of the pre-collision system yourself, as the system may not operate or engage, possibly leading to an accident. In some situations, such as when driving in inclement weather such as heavy rain, fog, snow or a sandstorm or while driving on a curve and for a few seconds after driving on a curve, a vehicle or pedestrian may not be detected by the radar and camera sensors, preventing the system from operating or engaging properly.

Refer to the Toyota Owner's Manual for a list of additional situations in which the system may not operate properly.

See www.toyota.com/safety-sense for more information.

Refer to the Toyota Owner's Manual for a list of additional situations in which the system operation may be limited.

Pre-Collision Warning

When the system determines that the possibility of a frontal collision is high, a buzzer will sound and a warning message will be displayed on the Multi-Information Display (MID) to urge the driver to take evasive action.

Pre-Collision Brake Assist

If the driver notices the hazard and brakes, the system may provide additional braking force using Brake Assist. This system may prime the brakes and may apply greater braking force in relation to how strongly the brake pedal is depressed.

Pre-Collision Braking

If the driver does not brake in a set time and the system determines that the possibility of a frontal collision with a preceding vehicle is extremely high, the system may automatically apply the brakes, reducing speed in order to help the driver reduce the impact and in certain cases avoid the collision.

TOYOTA SAFETY SENSE™

PCS PEDESTRIAN DETECTION

Under certain conditions, the PCS system included with the TSS-P package may also help to detect a pedestrian in front of your vehicle using the forward-facing camera and the front grille-mounted radar. The forward-facing camera of PCS detects a potential pedestrian based on size, profile, and motion of the detected pedestrian. However, a pedestrian may not be detected depending on the conditions, including the surrounding brightness and the motion, posture, size, and angle of the potential detected pedestrian, preventing the system from operating or engaging.

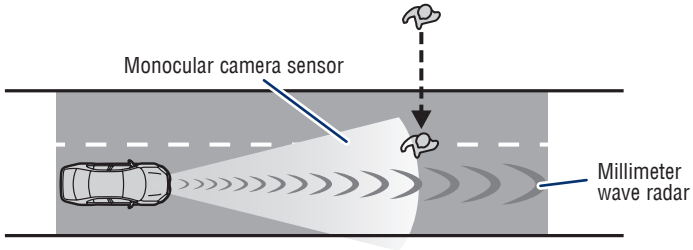



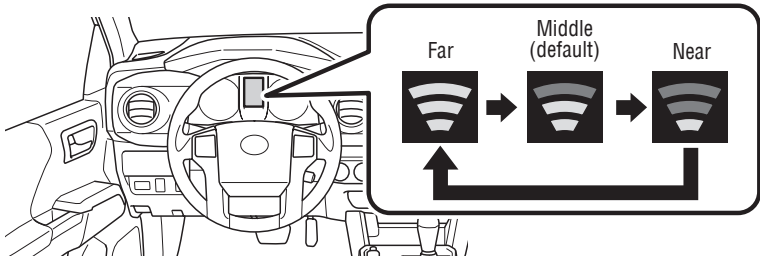

As part of the Pre-Collision System, this function is also designed to first provide an alert and then automatic braking if needed.

Refer to the Toyota Owner's Manual for additional limitations and information.

CHANGING PCS ALERT TIMING





- (1) Press “<>” switches and select  from the Multi-Information Display (MID).
 - (2) Press “<>” switches and select “PCS” and then press “.
 The setting screen is displayed. - (3) Select “Sensitivity” and then press “.
- (4) Press “>” to go back to the menu. Also, use “” to switch menus or display top screen.

Note: PCS is enabled each time the vehicle is turned on. The system can be disabled/enabled and the alert timing of the system can be changed. (Alert timing only, brake operation remains the same.)

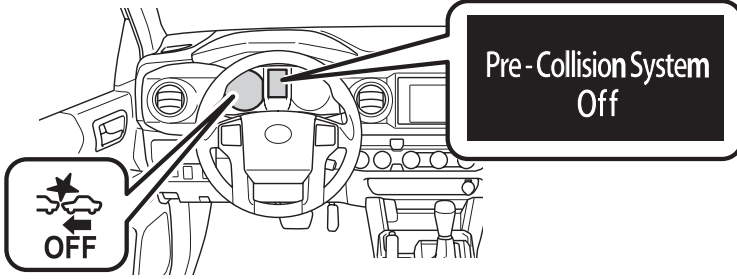
DISABLING PRE-COLLISION SYSTEM (PCS)



- (1) Press “<>” switches and select  from the Multi-Information Display (MID).
- (2) Press “⬆” switches and select “PCS” and then press “” to turn PCS on or off.
- (3) Press “➔” to go back to the menu. Also, use “” to switch menus or display top screen.

Refer to the Toyota Owner's Manual for additional information on PCS w/PD operation, settings adjustments, limitations, and precautions before attempting to use it.

Lane Departure Alert (LDA)

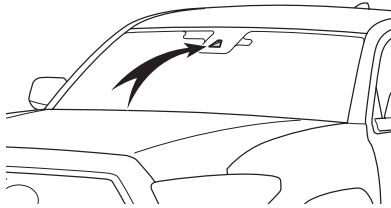

By detecting visible white/yellow lane markings at speeds above 32 mph, Lane Departure Alert (LDA) is designed to issue an audio/visual alert if an inadvertent lane departure is detected.

See www.toyota.com/safety-sense for more information.

Refer to the Toyota Owner's Manual for a list of additional situations in which the system operation may be limited.

TOYOTA SAFETY SENSE™

TURNING THE LDA SYSTEM ON/OFF

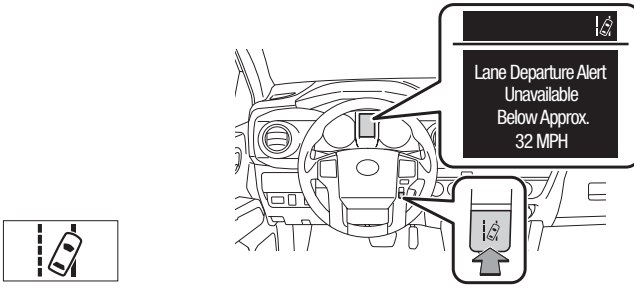

Press the LDA switch to turn the LDA system on. Depress again to turn it off.

Note: Operation of the LDA system and setting adjustments continues in the same condition regardless of ignition cycle until changed by the driver or the system is reset.

LANE DEPARTURE ALERT

LDA function display

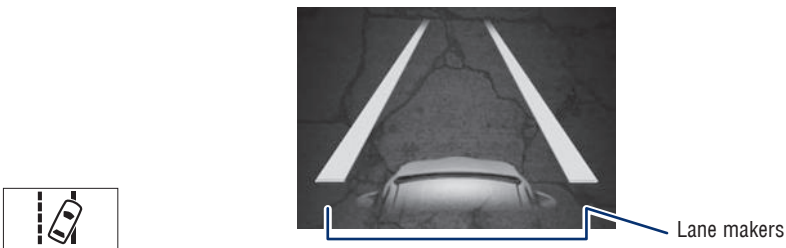

Lane Departure Alert (LDA) indicator's illumination shows the system operation status.

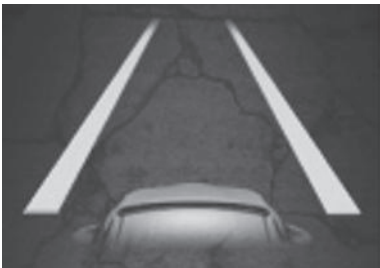

(1)

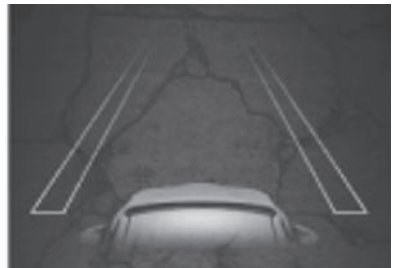

(2)

LANE DEPARTURE ALERT (CONTINUED)

The LDA function  displays when the Multi-Information Display (MID) is switched to the driving assist system information screen.

- (1) The system displays solid white lines on the LDA indicator when visible lane markers on the road are detected. A side flashes orange to alert the driver when the vehicle deviates from its lane.
- (2) The system displays outlines on the LDA indicator when lane markers on the road are not detected or the function is temporarily canceled.





Note: When operation conditions are no longer met, a function may be temporarily canceled. However, when the operation conditions are met again, operation of the function is automatically restored. For example, LDA may not function on the side(s) where white/yellow lines are not detectable.

ADJUSTING LDA ALERT SENSITIVITY

The driver can adjust the sensitivity of the LDA (warning) function from the Multi-Information Display (MID) customization screen.

High - Is designed to warn approximately before the front tire crosses the lane marker.

Standard - Is designed to warn approximately when the front tire crosses the lane marker.

- (1) Press “<>” switches and select  from the Multi-Information Display (MID).
 - (2) Press “<>” switches and select “LDA” and then press “.
 The setting screen is displayed. - (3) Select “ Sensitivity” and then press “.
- (4) Press “<>” to go back to the menu. Also, use “” to switch menus or display top screen.

Note: Operation of the LDA system and setting adjustments continues in the same condition regardless of ignition cycle until changed by the driver or the system is reset.

SWAY WARNING SYSTEM



Continuous lane deviations from swaying.

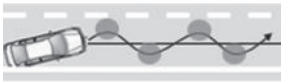





Gentle swaying from driver's inattentiveness.







Acute steering wheel operation after the number of operations decrease due to driver's inattentiveness.

Sway warning is a function of LDA and is designed to detect swaying based on the vehicle location in the lane and the driver's steering wheel operation. To help prevent swaying, the system alerts the driver using a buzzer sound and a warning display on the MID.

DISABLING LDA SWAY WARNING SYSTEM

- (1) Press “<>” switches and select  from the Multi-Information Display (MID).
 - (2) Press “<>” switches and select “LDA” and then press “.
 The setting screen is displayed. - (3) Select “ Warning” and then press “.
- (4) Press “>” to go back to the menu. Also, use “” to switch menus or display top screen.

ADJUSTING SWAY ALERT SENSITIVITY

- (1) Press “<>” switches and select  from the Multi-Information Display (MID).
 - (2) Press “<>” switches and select “LDA” and then press “.
 The setting screen is displayed. - (3) Select “ Sensitivity” and then press “.
- (4) Press “>” to go back to the menu. Also, use “” to switch menus or display top screen.

Note: Operation of the LDA system and setting adjustments continues in the same condition regardless of ignition cycle until changed by the driver or the system is reset.

Refer to the Toyota Owner's Manual for additional information on LDA operation, settings adjustments, limitations, and precautions before attempting to use it.

Dynamic Radar Cruise Control (DRCC)

Intended for highway use, Dynamic Radar Cruise Control (DRCC) lets you drive at a preset speed. DRCC is designed to function at speeds of 25-110 mph and uses vehicle-to-vehicle distance control, helping maintain a preset distance from the vehicle ahead of you.

See www.toyota.com/safety-sense for more information.

Refer to the Toyota Owner's Manual for a list of additional situations in which the system operation may be limited.

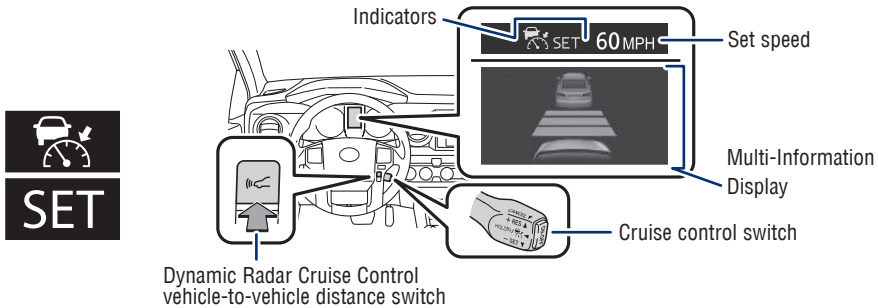

TURNING SYSTEM ON/OFF

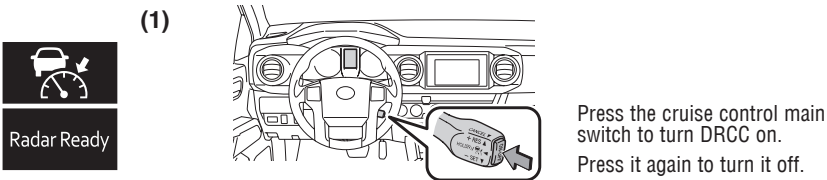

Refer to page 39 for switching to Constant Speed (Cruise) Control Mode.

ADJUSTING SET SPEED

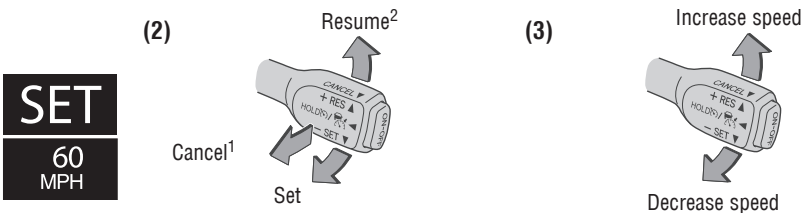

Vehicle will cruise at a set speed, decelerate to maintain a selected distance from a slower vehicle traveling in front and accelerate back up to the selected speed if the vehicle in front changes lanes or speeds up.

- (1) Push the ON-OFF button. The "Radar Ready" and " " indicator will come on.
- (2) Push the lever down to set speed, push it up to resume and pull it or depress brake to cancel.
- (3) Push up to increase the set speed, push down to decrease (1 mph [1.6 km/h] or 1 km/h [0.6 mph] increments.)

¹ The speed control may also be canceled by depressing the brake pedal.

² The speed control may be resumed once vehicle speed exceeds 25 mph (40 km/h).

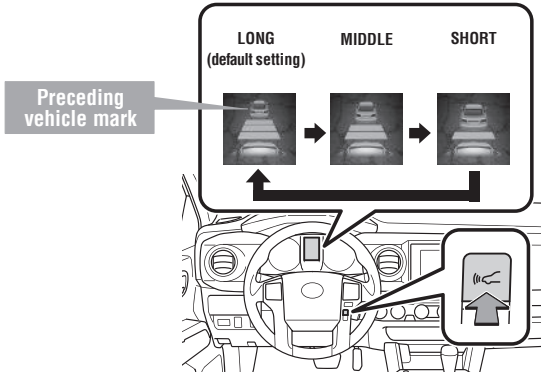

To change the vehicle-to-vehicle distance:

Push the “” switch to cycle through the settings, which will change progressively.

This mode employs a radar sensor to detect the presence of a preceding vehicle up to approximately 328 ft (100 m) ahead, determines the current vehicle-to-vehicle following distance and operates to maintain a preset following distance from the vehicle ahead. These distances vary based on vehicle speed.

Note: Vehicle-to-vehicle distance will close in when traveling on long downhill slopes.

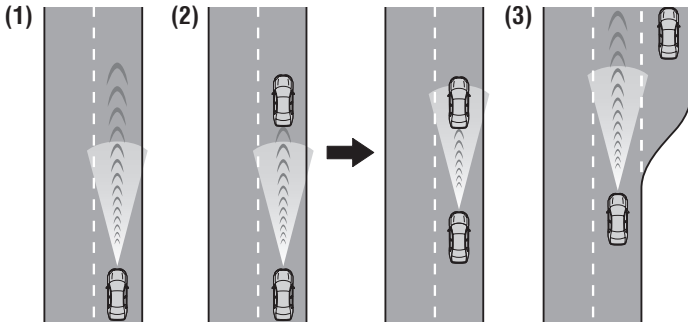

(1) Constant speed cruising when there are no vehicles ahead

The vehicle travels at the speed set by the driver. The desired vehicle-to-vehicle distance can also be set by operating the vehicle-to-vehicle distance control switch.

(2) Deceleration cruising and follow-up cruising when a preceding vehicle driving slower than the set speed appears

When a slower vehicle is detected running ahead of you, the system automatically decelerates your vehicle. When a greater reduction in vehicle speed is necessary, the system may apply the brakes (the brake lights will come on at this time.) The system will respond to changes in the speed of the vehicle ahead in order to maintain the vehicle-to-vehicle distance set by the driver. A warning tone warns you when the system cannot decelerate sufficiently to prevent your vehicle from closing in on the vehicle ahead.

DRCC ADJUSTING DISTANCE (CONTINUED)

(3) Acceleration when there are no longer any preceding vehicles driving slower than the set speed

The system accelerates until the set speed is reached. The system then returns to constant speed cruising.

Note: When your vehicle is too close to a vehicle ahead, and sufficient automatic deceleration via the cruise control is not possible, the display will flash and the buzzer will sound to alert the driver. An example of this would be if another driver cuts in front of you while you are following a vehicle. Depress the brake pedal to ensure an appropriate vehicle-to-vehicle distance.

SWITCHING TO CONSTANT SPEED (CRUISE) CONTROL MODE

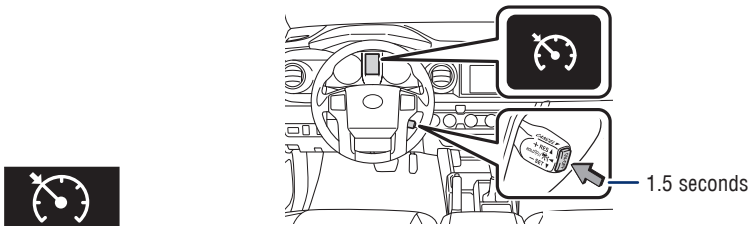

If you are already using DRCC “,” push the ON-OFF button again to turn the system off first, then push and hold the button for at least 1.5 seconds to switch.

Note: When the engine is turned off, it will automatically default to DRCC.

SETTING CONSTANT SPEED (CRUISE) CONTROL

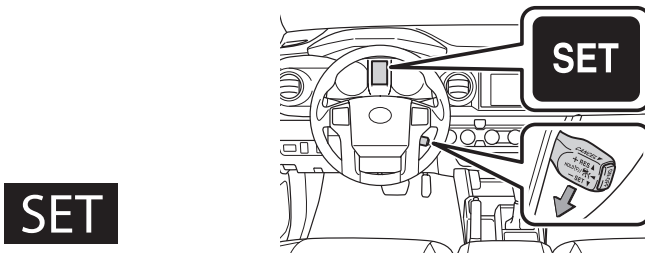

To adjust speed or cancel, see steps (2) and (3) of ADJUSTING SET SPEED on page 37.

Refer to the Toyota Owner's Manual for additional information on DRCC operation, settings adjustments, limitations, and precautions before attempting to use it.

Automatic High Beams (AHB)

(1)

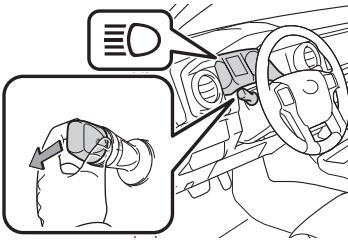

(2)

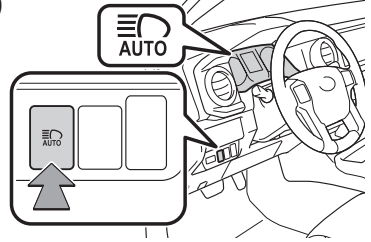



The Automatic High Beams (AHB) safety system is designed to help you see more clearly at night. At speeds above 25 mph, AHB can detect the headlights of oncoming vehicles and taillights of preceding vehicles, then automatically toggles between high and low beams accordingly.

See www.toyota.com/safety-sense for more information.



Refer to the *Toyota Owner's Manual* for additional information on AHB operation, settings adjustments, limitations, and precautions before attempting to use it.

ACTIVATING THE AHB SYSTEM

- (1) Push the lever away from you with the headlight switch is in the “” or “AUTO” (if equipped) position.
- (2) Press the “” switch.

The AHB indicator will come on when the headlights are turned on automatically to indicate that the system is active.

Note: Pull the lever back toward you or press the AHB switch to turn the AHB system off.

The AHB indicator will turn off and “” or “” will turn on. To activate the system again, push the lever away from you or press the “” switch.

CONDITIONS WHERE AHB WILL TURN ON/OFF AUTOMATICALLY

When all of the following conditions are met, the high beams will be automatically turned on (after approximately 1 second):

- Vehicle speed is above approximately 21 mph (34 km/h).
- The area ahead of the vehicle is dark.
- There are no oncoming or preceding vehicles with headlights or tail lights turned on.
- There are few streetlights on the road ahead.

If any of the following conditions occur, the high beams will be automatically turned off:

- Vehicle speed drops below approximately 17 mph (27 km/h).
- The area ahead of the vehicle is not dark.
- Oncoming or preceding vehicles have headlights or tail lights turned on.
- There are many streetlights on the road ahead.

Seat belts

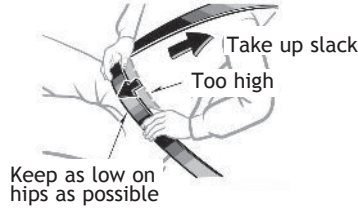

NOTE: If a passenger's seat belt is fully extended, then retracted even slightly, the Automatic locking retractor (ALR) will prevent it from being re-extended beyond that point, unless fully retracted again. This feature is used to help hold child restraint systems securely.

To find more information about seat belts, and how to install a child restraint system, refer to the Owner's Manual.

Seat belts-Shoulder belt anchor

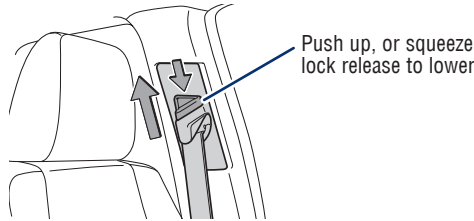

Safety Connect®

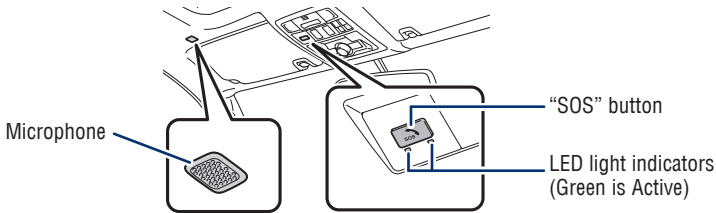

Safety Connect is a subscription-based telematics service that uses Global Positioning System (GPS) data and embedded cellular technology to provide safety and security features to subscribers. Safety Connect is staffed with live agents at the Toyota response center, which operates 24 hours per day, 7 days per week.

Services for subscribers include:

- Automatic collision notification
- Stolen vehicle locator
- Emergency assistance ("SOS" button)
- Enhanced roadside assistance

For limitations and additional information, refer to the "Owner's Manual" or visit www.toyota.com/connected-services.

SAFETY & EMERGENCY FEATURES

Tire Pressure Monitoring (warning) System (TPMS)

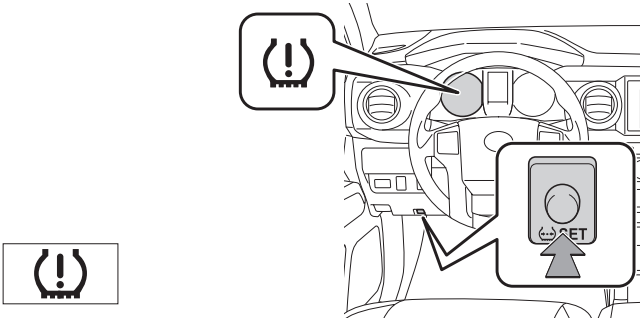

After adjusting tire pressures, or after tires have been rotated or replaced, turn the vehicle on and press and hold the “SET” button until the indicator blinks three times. Let the vehicle sit for a few minutes to allow initialization to complete. Drive the vehicle at approximately 25 mph (40 km/h) or more for approximately 10 minutes.

The tire pressure detected by the tire pressure warning system can be displayed on the Multi-Information Display. (Available on select grades.)

If the tire pressure indicator flashes for 1 minute and then remains on, take the vehicle to your local Toyota dealer.

Refer to the load label on the door jamb or the Owner's Manual for tire inflation specifications.

NOTE: The warning light may come on due to temperature changes or changes in tire pressure from natural air leakage. If the system has not been initialized recently, setting the tire pressures to factory specifications should turn off the light.

Rear door child safety locks (Double Cab models only)

Rear door

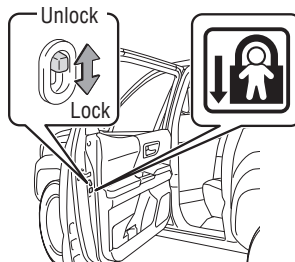

Moving the lever downward will allow the door to be opened only from the outside.

Spare tire & tools

TOOL LOCATION

Double Cab models
-under the rear seat

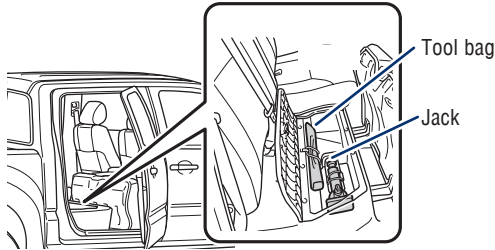

Access Cab models
-under the rear seat

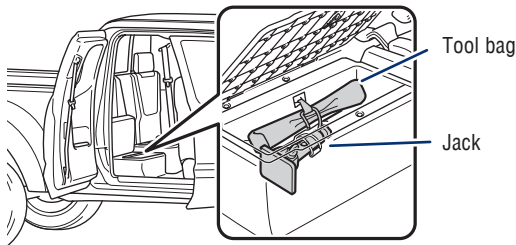

REMOVING THE SPARE TIRE

Assemble the jack handle.

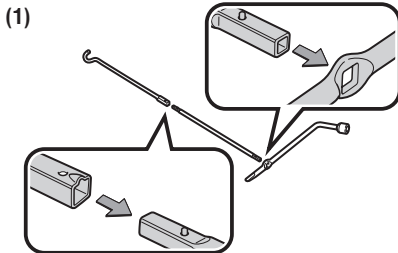

Insert the jack handle end into the lowering screw.

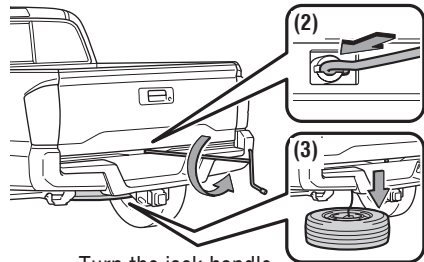

Turn the jack handle counterclockwise.

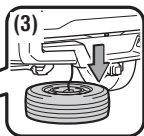

Refer to the Owner's Manual for tire changing and jack positioning procedures.

SAFETY & EMERGENCY FEATURES

Star Safety System™

Your vehicle comes standard with the Star Safety System™, which combines Anti-lock Braking System (ABS), Brake Assist (BA), Electronic Brake-force Distribution (EBD), Smart Stop Technology (SST), Traction Control (TRAC) and Vehicle Stability Control (VSC).

Refer to the Owner's Manual for more details and important information on limitations to these systems.

ANTI-LOCK BRAKE SYSTEM (ABS)

Toyota's Anti-lock Brake System detects which wheels are locking up and limits wheel lockup by "pulsing" each wheel's brakes independently. Pulsing releases brake pressure repeatedly for fractions of a second. This helps the tires attain the traction that current road conditions will allow, helping you to stay in directional control.

BRAKE ASSIST (BA)

Brake Assist is designed to detect sudden or "panic" braking, and then add braking pressure to help decrease the vehicle's stopping distance. When there's only a split second to react, Brake Assist can add additional brake pressure more quickly than just the driver alone can.

ELECTRONIC BRAKE FORCE DISTRIBUTION (EBD)

Toyota's ABS technology has Electronic Brake-force Distribution (EBD) to help maintain control and balance when braking. EBD responds to sudden stops by redistributing brake force to enhance the braking effectiveness of all four wheels.

SMART STOP TECHNOLOGY (SST)

Smart Stop Technology automatically reduces engine power when the accelerator and brake pedals are pressed simultaneously under certain conditions.

SST engages when the accelerator is depressed first and the brakes are applied firmly for longer than one-half second at speeds greater than five miles per hour.

SST doesn't engage if the brake pedal is depressed before the accelerator pedal, allowing vehicles to start on a steep hill and safely accelerate without rolling backward.

VEHICLE STABILITY CONTROL (VSC)

VSC helps prevent loss of traction during cornering by reducing engine power and applying brake force to selected wheels.

Toyota's VSC monitors steering angle and the direction your vehicle is traveling. When it senses that the front or rear wheels begin to lose traction, VSC reduces engine power and applies braking to selected wheels. This helps restore traction and vehicle control.

TRACTION CONTROL (TRAC)

VSC helps prevent loss of traction during cornering by reducing engine power, and Traction Control helps maintain traction on loose gravel and wet, icy, or uneven surfaces by applying brake force to the spinning wheel(s).

Toyota's TRAC sensors are activated when one of the drive wheels starts to slip. TRAC limits engine output and applies the brakes to the spinning wheel. This transfers power to the wheels that still have traction to help keep you on track.

Floor mat installation

There are two types of Toyota floor mats: carpeted and all-weather. Each vehicle has model-specific floor mats. Installation is easy.

To keep your floor mat properly positioned, follow these steps:

- Only use Toyota floor mats designed for your specific model.
- Only use one floor mat at a time, using the retaining hooks to keep the mat in place.
- Install floor mats right side up.

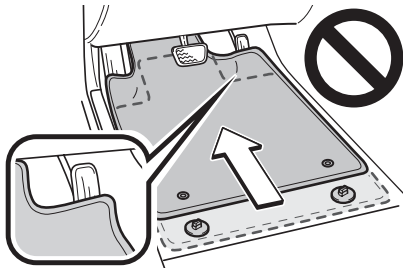
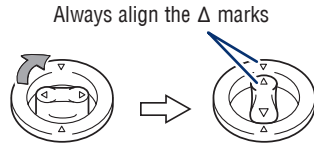
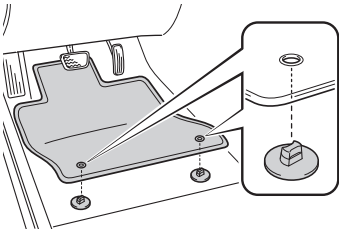

BLUETOOTH® DEVICE PAIRING SECTION

Do not attempt the Bluetooth® Pairing process while driving.

To begin the Bluetooth® Pairing process, press the HOME button.

Bluetooth® Pairing for your phone

Pairing your phone is the first step in connecting with your Toyota. This pairing process is quick and easy. All you have to do is setup the phone and multimedia system to form a connection.



Audio / Audio Plus / Premium Audio

STEP 1 Press [MENU], then select "Setup" on display screen.

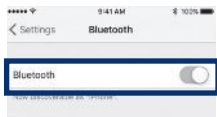

iPhone bluetooth Menu

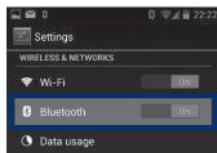

Android bluetooth Menu¹

STEP 2 Ensure Bluetooth is turned on for your phone.

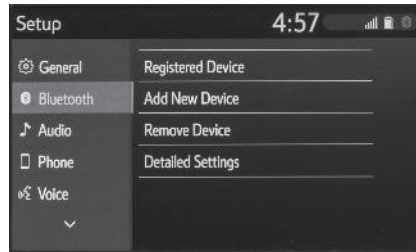

STEP 3 Select "Bluetooth," then select "Add New Device" on display screen.

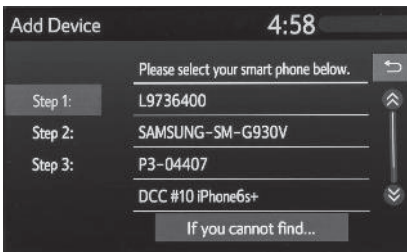

STEP 4 Select "Phone Name."

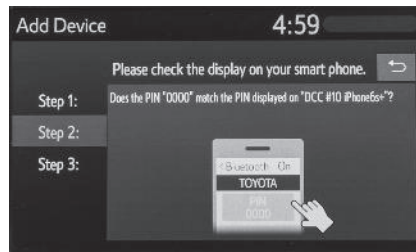

STEP 5 Check the display on your phone. Does the PIN XXXX match the PIN displayed? If it does, select "Pair."

¹ Some Android devices may have slightly different SETTINGS screen layout depending on manufacturer of device and Android OS version.

Bluetooth® Pairing for your phone (cont.)

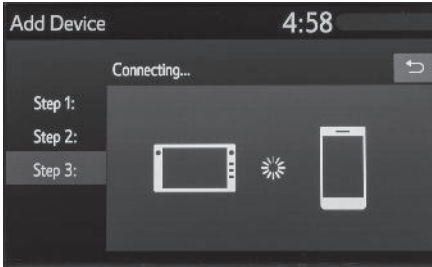

STEP 6 "Connecting" displays while phone is forming the connection to the multimedia system.



STEP 7 Enable Notifications (text message). While pairing your phone, a message will be displayed: **"You may need to allow message access on your phone."**

Note: You may also select "Skip" on display screen to skip enabling notifications. If skipped, proceed to **Step 8**.

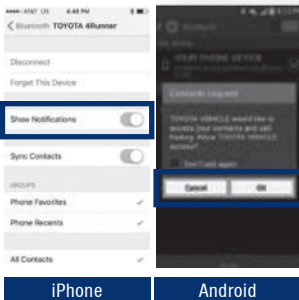

STEP 8 Turn on "Show Notifications" for iPhone or "ON" for Android.

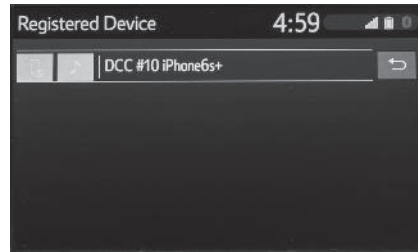

STEP 9 A confirmation will appear once your phone has been paired and connected.



TACOMA

Quick Reference Guide 2022



00505QRG22TAC



Printed in U.S.A. 8/21
21-MKG-15675

toyota.com